

# City of St. Helens Branding & Wayfinding Master Plan

---

RESOLUTION NO. 1800

October 2017



*prepared by:*  
Alta Planning + Design  
711 SE Grand Avenue  
Portland, Oregon 97214





# TABLE *of* CONTENTS

	<b>Executive Summary</b>
	Preferred Design
<b>1</b>	<b>Introduction</b>
	Overview
	Background Review
	Objectives
	Wayfinding Principles
<b>2</b>	<b>Information Scan</b>
	St. Helens' Existing Wayfinding System
<b>3</b>	<b>Best Practices</b>
	Fundamental Navigational Elements
	Enhanced Navigational Elements
	Wayfinding Sign Placement Guidance
	Accessibility Standards
<b>4</b>	<b>Mapping</b>
	Destination Hierarchy
	Approved Destinations
	Mental Mapping
	Sign Placement
	Route Prioritization

<b>5</b>	<b>Design</b>
	Design Process
	Design Options
	Preferred Design
<b>6</b>	<b>Appendices</b>
	Appendix A: References
	Appendix B: Design Intent



This project was made possible in part by a grant from Travel Oregon.



# Executive Summary

*The **City of St. Helens Branding and Wayfinding Master Plan** provides a strategy for the City to implement a citywide wayfinding system*

*The City of St. Helens is located on the Columbia River, north of Portland, Oregon. Highway 30, which follows the path of the Columbia River to the Pacific Ocean, runs through the community and serves as a major transportation route for commercial and recreational trips. St. Helens has a resident population of approximately 13,000 people and welcomes visitors throughout the year. St. Helens was established as a river port on the Columbia River in the 1840s and still has a strong connection to the river for recreational and commercial activities.*

The City of St. Helens Branding and Wayfinding Plan provides a strategy for the City to implement a citywide wayfinding system. This plan provides guidance on sign placement and route prioritization, in addition to a preferred design for a family of wayfinding signs.

The preferred design incorporates national best practices, community input, local materials, and distinctive architectural details to create a unique wayfinding identity rooted in the history and landscape of St. Helens.



The historic 1906 Columbia River Courthouse with Mount St. Helens in the background.

# Preferred Design

The family of wayfinding elements for St. Helens will define a sense of place in a way that is clear and simple, reflects local character, and integrates well among other landscape, streetscape, and transportation elements.

The bright, clean, and modern interpretation of a nautical color palette will be used throughout the sign family, with large and legible text. The soft arching wave shape will be used in the top of the larger signs, with color

coded directional arrows and pavement markings used to indicate the district. The sign poles are chosen to match the existing, historic light poles in St. Helens.

The Gateway Arch, to be placed over Columbia Boulevard, will be constructed of painted aluminum for ease of maintenance.

## Enhanced Navigational Elements - Off Street Signage

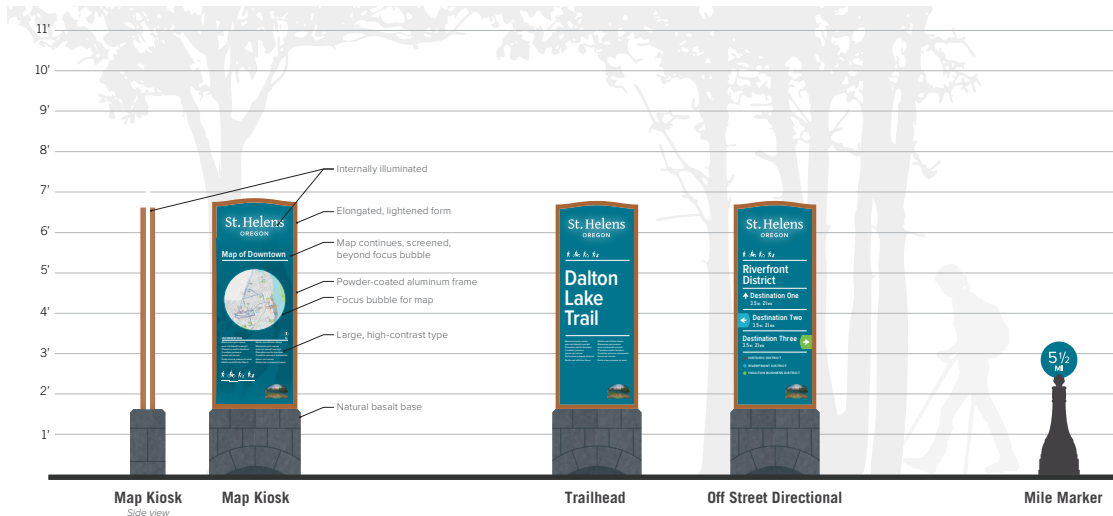
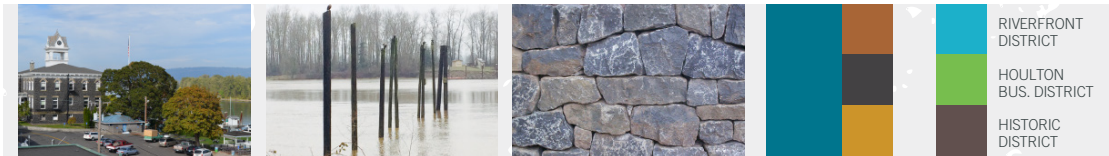

### Fundamental Navigational Elements - On Street Signage

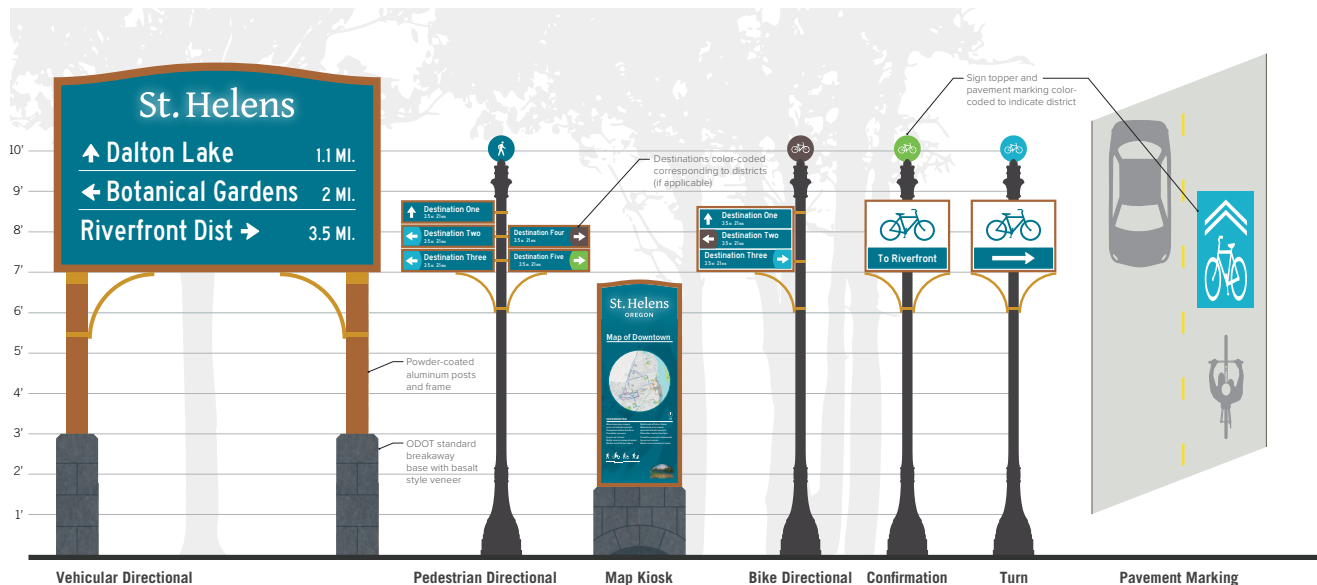

### Identity Signage

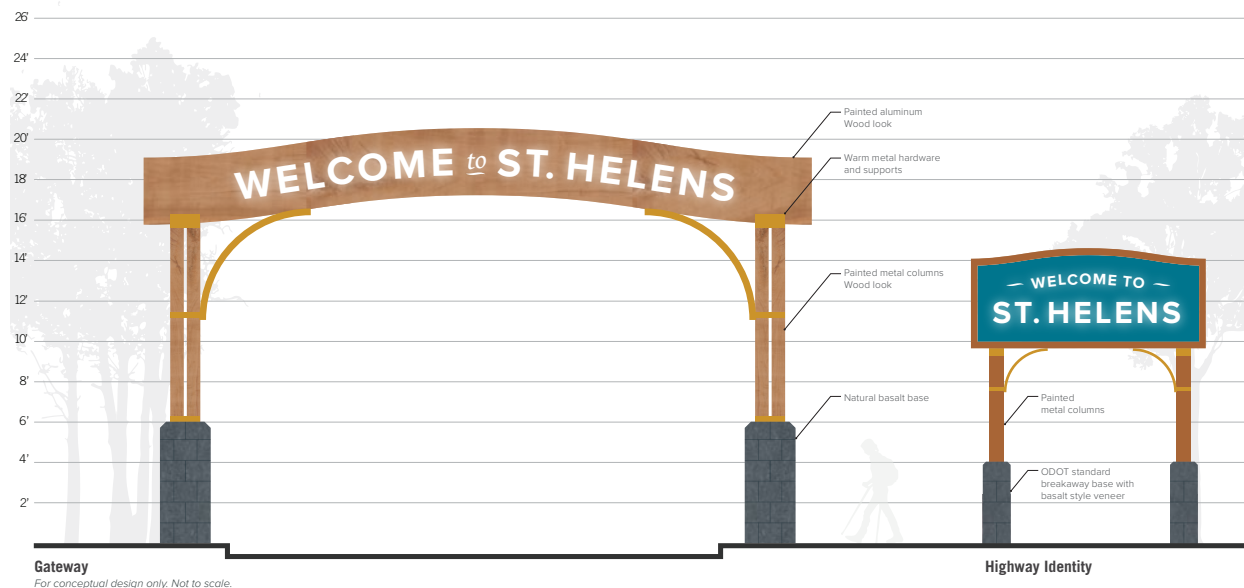



## Chapter 1

# Introduction

*The **City of St. Helens Branding and Wayfinding Master Plan** provides a strategy for the City to implement a citywide wayfinding system. The plan is a product of the community's goals to connect residents and visitors to city services and destinations like the Riverfront, to support and enhance tourism, and to encourage travel off Highway 30 and into St. Helens.*



*With its beautiful riverfront location, Historic District, and access to Highway 30, St. Helens offers a unique visitor and shopping experience.*

Strategically placed and branded wayfinding signage will help both visitors and residents navigate to key points of interest in the City. Unified directional signage, informational kiosks, and gateways will enliven business districts by making them easier to locate from Highway 30, increasing foot traffic, and encouraging visitors to explore different parts of the City once they have arrived. Most St. Helens amenities are to the east of Highway 30; therefore, the planning effort focused on the area between the highway and the Columbia River.



There are many destinations and attractions throughout St. Helens, including the river, commercial districts, and parks.

## Overview

The City of St. Helens is located on the Columbia River, north of Portland, Oregon. Highway 30, which follows the path of the Columbia River to the Pacific Ocean, runs through the community and serves as a major transportation route for commercial and recreational trips. St. Helens has a resident population of approximately 13,000 people and welcomes visitors throughout the year. St. Helens was established as a river port on the Columbia River in the 1840s and still has a strong connection to the river for recreational and commercial activities.

St. Helens has two commercial districts (in addition to the commercial corridor along Highway 30) – the Historic District downtown and the Houlton Business District to the west near Highway 30. The Historic District is situated near the river and is defined by walkable streets, historic storefronts, and mature street trees. The Houlton Business District is less densely built than the Historic District and contains more surface parking lots and empty lots.

Effective wayfinding is important as residents and visitors explore St. Helens through different modes of transportation, including walking, biking, and driving, and from different entry points. This plan provides a comprehensive and consistent approach for wayfinding signage that will benefit the entire City.



Art along a roadway provides visual interest and a sense of place in St. Helens.



A historic photo of St. Helens showing the corner of 4th and Old Portland Road.

A good wayfinding system equips residents and visitors with easy to read information allowing a logical, intuitive experience by which to explore a local area, its services, and attractions. Clean and concise navigation information creates a welcoming experience and signage is an effective investment to encourage tourism and improve access to local destinations.

## Background Review

In developing the Branding and Wayfinding Master Plan, municipal plans and policies were reviewed in relation to multi-modal transportation and wayfinding signage.

In the following documents, there are references to Old Town/Olde Towne/ Riverfront District. In order to better reflect the City's future redevelopment, City Council changed the district name from Olde Towne to Riverfront District.

### **St. Helens Waterfront Framework Plan**

The St. Helens Waterfront Framework Plan (2016) calls for wayfinding improvements to “help people find downtown retail and existing business district, attract people on Hwy 30 to St. Helens downtown, and integrate corridor master planning and other efforts.” The plan goes on to say that “there is a perception that Old Town and especially the waterfront are hard to find from Highway 30. A wayfinding program would help promote existing businesses and attractions and provide greater ease of travel for visitors”.

### **St. Helens Municipal Code: Community Development Code**

Section 17.88: “Signs” provides guidance on signs in St. Helens. The stated purpose of the sign code is to “improve the effectiveness of signs, to provide for safe construction, location, erection and maintenance of signs, to prevent proliferation of signs and sign clutter, to minimize adverse visual safety factors to travelers on public highways and streets and on private areas open to public travel”. The code provides guidance on sign size, placement, illumination restrictions, and when design review is required.

### **Architectural Design Guidelines for the Conversation of Traditional Design in Olde Towne**

The Architectural Design Guidelines for the Conversation of Traditional Design in Olde Towne, St. Helens (2012), while not providing specific guidance on wayfinding, offers guidance on lighting, commercial signage, and material and color palettes.

### **City of St. Helens Parks and Trails Master Plan**

The City of St. Helens Parks and Trails Master Plan (2012) recommends providing wayfinding signage along high boat



Downtown St. Helens

traffic areas, such as water trails, at Sand Island Marine Park, Grey Cliffs Park, and Columbia View Waterfront Park, to capitalize on the boat traffic generated by the Columbia River. The Parks and Trails Master Plan also recommends adding interpretive installations, kiosks, and wayfinding signage along trail routes, as well as utilizing the St. Helens Arts and Cultural Commission or local artists to provide art along trail systems.

### **St. Helens Economic Development Corporation's Local Program Evaluation**

The St. Helens Economic Development Corporation's Local Program Evaluation (2015) recommends the City "embrace a bike friendly program" and capitalize on

its unique setting along a popular cycling route between Portland and the Pacific Ocean. The recommendation calls for the creation of bicycle-oriented signage along Highway 30 to bring cyclists onto Main Street. The plan also recommends highway signage on Highway 30 and "standard attraction and amenities signs within (ODOT's) right-of-way". The consideration of a gateway sign that reaches across Columbia Boulevard near the highway is also recommended.

### **City of St. Helens Planning Department Memorandum on Sign Pollution Concerns**

The City of St. Helens Planning Department Memorandum on Sign Pollution Concerns (2011) discusses the

City's concern with the use of signs and their impact to the City's appearance, including the resulting sign pollution. The memo notes that public signs (SHMC 17.88.015) are signs "placed by or with the approval of government within the right-of-way. Examples include street and traffic signage. No permit required." The memo recommends using ODOT-approved advertising signage (applicable to the highway only) for tourist-oriented directional signs and signs through the Oregon Travel Information Council.

### Corridor Master Plan

The Corridor Master Plan (2015) recommends the installation of wayfinding signage, community kiosks, and gateway markers in greater downtown area of St. Helens (Houlton and Riverfront Districts), in order to improve aesthetics and sense of place. Specific recommendations call for a gateway at the US 30 / Columbia Boulevard intersection, with additional gateway elements at 13th Street to mark the entrance to Houlton's commercial couplet, and one at Columbia Boulevard and 1st Street to make the entrance of the Riverfront District. Another specific recommendation is to install a community kiosk mid-block on the south side of Columbia Boulevard at 16th Street, adjacent to the St. Helens Post Office.



The neon City Hall sign offers an interesting contrast against the historic stone building.

### Towards Sustainable Tourism

Towards Sustainable Tourism (2007) recommends new waterfront signage on the Columbia River to "welcome boaters into downtown St. Helens", in addition to wayfinding signage along the Columbia River Highway that is artistic and includes important wording such as "historical" and "riverfront".

## Objectives

The City of St. Helens Branding and Wayfinding Master Plan is designed to create a comprehensive and cohesive wayfinding system, along with a plan for implementing signage to serve residents and visitors who are walking, biking, and driving in St. Helens. The plan aims to:

- Create wayfinding signage that will meet the needs of residents and visitors whether traveling through St. Helens as a pedestrian, in a motor vehicle, or by transit or cycling.
- Establish a high quality brand identity and design that captures local character and is coherent and attractive.
- Consider graphic standards focused on local identity and aesthetic.
- Understand key entrances and gateways to St. Helens, including decision points and sites where navigation information is suited.
- Give sign placement guidance for specific corridors or areas of the community.



St. Helens has many important destinations that draw both local residents and visitors.

## Wayfinding Principles

The “legibility” of a place describes how easy it is to understand. Places are more legible when they are arranged so people can intuitively determine the location of destinations, identify routes, and recognize areas of different character. A wayfinding system helps to make places more legible by better enabling individuals to:

- Easily and successfully find their destination.
- Understand where they are with respect to other key locations.
- Orient themselves in an appropriate direction with little misunderstanding or stress.
- Discover new places and services.

The following guiding principles, based on best practices from around North America, will help create the most effective wayfinding systems. Together, these wayfinding principles create a wayfinding system plan that is both legible and easy to navigate. These principles should be applied in St. Helens’ wayfinding sign placement and destination logic to effectively enhance the legibility of the community.

## Wayfinding Principles:



### Be Predictable

Effective wayfinding networks are predictable. When information is predictable, patterns emerge, and users of the network are able to rely on the system to provide information when they expect it. Predictability also helps users understand new situations quickly, whether it be navigating a new intersection or traveling to a destination for the first time.

Users come to trust a predictable wayfinding network, making new journeys easier to attempt and complete. Every time a new trip is completed, users' confidence in the wayfinding network will be sustained or increased.

Predictability should relate to all aspects of wayfinding placement and design (i.e., sign materials, dimensions, colors, forms, and placement). Similarly, maps should employ consistent symbology, fonts, colors, and style. The system must be designed in accordance with local, state, and federal guidelines to ensure funding eligibility through state and federal sources.



### Keep Information Simple

For a wayfinding network to be effective, information needs to be presented clearly and logically. The presentation of information needs to be balanced: too much information can be difficult to understand; too little and decision-making becomes impossible. The placement of signs and the information provided at each placement are also critical. To be successful, wayfinding information must be provided in advance of where major changes occur and confirmed when the maneuver is complete.

Wayfinding signage design should be accessible and comprehensible by a wide range of users, including people of all ages and ability levels. Special consideration should be taken for those without high educational attainment, English language proficiency, or spatial reasoning skills. In areas with high rates of users with English as a second language, the wayfinding should use text and symbols that will be understood by non-English speakers. Designers should minimize the use of bilingual text or separate-language signs, as including these elements can make signs cluttered and reduce overall legibility.

It is important to provide information in manageable amounts. Too much information can be difficult to understand; too little and decision-making becomes impossible.





## Maintain Motion

Bicycling and walking require physical effort, and frequently pausing to check directions may lead to frustration and discouragement. Consistent, clear, and visible wayfinding elements allow pedestrians and bicyclists to navigate while maintaining their state of motion. To help users maintain motion, wayfinding information must be quickly read and easily comprehended.



## Promote Active Travel

A wayfinding network should encourage increased rates of active transportation by creating a clear and attractive system that is easy to understand and navigate. The presence of wayfinding signs should communicate that walking and bicycling to many destinations is convenient

An effective wayfinding system makes active transportation facilities more visible and helps to increase use of both on-street and off-street facilities. Wayfinding improvements are a cost-effective way of drawing attention to existing facilities and how they connect people to the places they want to go.



## Connect Places

An effective wayfinding system enables residents and visitors alike to travel between destinations and discover new destinations and services. Wayfinding connects neighborhoods and provides navigational assistance to both local and regional destinations. Effective wayfinding is an extension of the transportation network and provides a seamless travel experience for people walking, biking, or driving.

Wayfinding connectivity goes beyond physical signage. Wayfinding signage elements can create a deeper connection to a place, cultivate a sense of pride by reflecting community values and identity, and support local economic development by encouraging residents and visitors to use services.

## Chapter 2

# Information Scan

*Understanding a community's signage and wayfinding needs begins with an exploration of the city including such places as popular parks, main transportation corridors, and commercial areas. Observing the existing conditions in St. Helens is a key element in developing a wayfinding plan.*

*To better understand the existing conditions and community, the project team explored St. Helens by motor vehicle and on foot. City corridors, districts, and destinations were visited to get a sense of the community and understand the experience of those living in and visiting St. Helens.*

St. Helens is comprised of two business districts that are over one mile apart. This separation poses challenges when trying to create a walkable commercial destination without wayfinding signage. The two districts, with surrounding neighborhoods and industrial or vacant areas, appears to be accessible by all modes of travel despite being largely oriented toward motor vehicle traffic. Sidewalks, bike lanes, and trails provide opportunities for walking and biking throughout St. Helens.



The Arts & Cultural Commission banners (above and following page) are attractive welcome banners in St. Helens.

## St. Helens' Existing Wayfinding System

The City of St. Helens has signage installed intermittently throughout the community. The City has implemented many different types of signs, ranging from fundamental wayfinding elements to celebrating local culture and achievements. The planning team reviewed existing signage conditions against the wayfinding principles presented in this plan and concluded the following:

- Some wayfinding exists in the city, but it is not comprehensive. There are long corridors with little to no wayfinding signage.
- Wayfinding signs have been installed at different times by different departments, resulting in a range of signage aesthetics.
- There is a general lack of standardization in sign information, hierarchy and placement practices.

Combined, these characteristics limit the effectiveness of the wayfinding system. The lack of signage consistency makes the system unpredictable and often difficult to understand. Additionally, signage is inconsistent and not always scaled appropriately based on location, making navigation between destinations difficult. There are many opportunities to improve St. Helens' wayfinding system. This section provides an overview of how the existing system performs according to each of the five wayfinding principles and indicates where opportunities for improvement exist.



### Gateway Signs

St. Helens has entrance and gateway signs along Highway 30. Banner signs and wood gateway structures are also wayfinding elements that welcome and orient people to the community.

The existing wayfinding signage is well designed. However, variation in graphic design elements and branding is inconsistent. Current welcome signs on the edge of the city feature simple timber design and are difficult to see from the highway. Additionally, the existing signage does not effectively represent the community character of St. Helens.



Examples of existing wayfinding signage in St. Helens includes gateway signage and banner signs.

### Wayfinding Signage

St. Helens has a mix of wayfinding signage directed at motor vehicles, pedestrians, and cyclists. Local tourism signs advertise the Riverfront District and Business District and destinations such as the Elks Lodge, the Amphitheater, and civic buildings.

Signage is varied in style, color, design, and scale and not uniformly located relative to destinations. Street signs, parking signs, or local destination signs are most effective when located at logical decision points. Pedestrians, cyclists, motorists, and transit users all need and use a range of signage to reach their destinations or to find their way around the community.



Signage is varied across St. Helens and lacks a consistent look and feel.

### ***Local Character and Identifying Elements***

St. Helens has a rich history of logging and ship building, with a strong connection to the Columbia River as a port town. Attractive local basalt stone is used as a construction material in many historic civic and residential buildings, in addition to historic infrastructure and retaining walls, throughout St. Helens. Weathered wood, remnants of the town's legacy as a ship building hub, dots the landscape and provide a maritime identity to the community.

Local art enhances the natural landscape, with motifs of fish, animals, and Native American-inspired patterns.



Historic architecture, scenic views, and local artwork are all part of St. Helens' unique character.

Chapter 3

# Best Practices

*The goal of wayfinding signage is to enhance the user's experience.*



Figure 1. Navigation Signage Elements

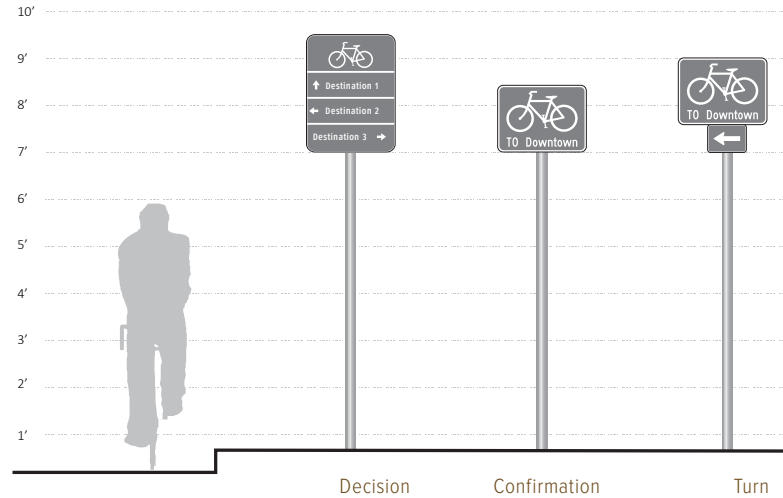

*This section describes the fundamental navigational elements that are recommended to increase legibility along St. Helens' on- and off-street network. This section also describes enhanced wayfinding tools that can be integrated into the wayfinding system to provide additional clarity and opportunities to create custom components reflecting the character of St. Helens.*

The fundamental and enhanced elements described apply to both the on-street and off-street transportation and recreation network.

Wayfinding elements reviewed in this section include:

#### **Fundamental Navigational Elements**

- Vehicular Oriented Decision sign
- On-street Bicycle Decision sign
- On-street Bicycle Confirmation sign
- On-street Bicycle Turn sign

#### **Enhanced Navigational Elements**

- Pavement Markings
- Mile Markers
- Map Kiosks
- Gateway Monuments
- Pedestrian Decision Sign
- Off-street Decision Sign
- Trailhead Identity Sign

## Fundamental Navigational Elements

The fundamental family of signs that provide navigational information consists of decision, confirmation, and turn signs. The function, content, and placement of each are described below.

### Vehicular Oriented Decision Signs

The Manual on Uniform Traffic Control Devices (MUTCD) is a document issued by the Federal Highway Administration of the United States Department of Transportation. It is the national standard for all traffic control devices installed on any street, highway, bikeway, or private road open to public travel.

While the MUTCD provides standards and guidelines for the design, size, and content of roadway signs (see pages 28-32 for more detail on these standards), many jurisdictions have implemented unique signs to enhance visibility or reinforce local identity (See Section 2D.50 Community Wayfinding Signs).

Figure 2. Vehicular Signage Placement

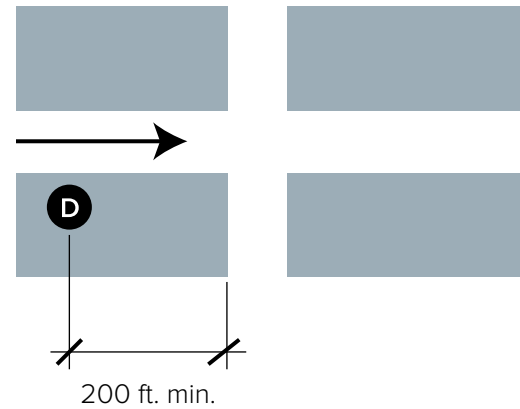

Vehicular signage should be located 200' from an intersection (MUTCD).

The following guidance is specified in the MUTCD:

#### *Devices should be designed so that:*

- Size, shape, color, composition, lighting or retroreflection, and contrast combine to draw attention to the devices.
- Size, shape, color, and simplicity of message combine to produce a clear meaning.
- Legibility and size combine with placement to permit adequate time for response.
- Uniformity, size, legibility, and reasonableness of the message combine to command respect.
- The correct font and size is used. (Federal approval required for font types other than Highway Gothic fonts).
- All letters have a minimum 6" height.
- Design layouts for conventional road guide signs show centerline spacing, edge spacing, and other specification details per the "Standard Highway Signs and Markings" book (see Section 1A.11).

***Size of Legend:***

- The longer the legend is on a guide sign, the longer it will take road users to comprehend it, regardless of letter size.
- Guide signs should be limited to no more than three lines of destinations, which include place names, route numbers, street names, and cardinal directions.
- The maximum length for a single destination title should be 19 characters (including spaces) in title case. The ideal maximum length for a single destination title is 10-14 characters (including spaces) in title case.

***Color Coded Districts:***

- Color coding is sometimes used on community wayfinding guide signs to help road users distinguish between multiple potentially confusing traffic generator destinations located in different neighborhoods or subareas within a community or area.
- Per the MUTCD, community wayfinding guide signs may use background colors other than green in order to provide a color identification for the wayfinding destinations by geographical area within the overall wayfinding guide signing system.

***Placement:***

- Locate community wayfinding signs away from intersections where high-priority traffic control devices are present.
- On curved alignments, determine the angle of placement by the direction of approaching traffic rather than by the roadway edge at the point where the sign is located.
- Community wayfinding guide signs can not be used to provide direction to highway routes or streets.

**Figure 3. Bicycle Decision Sign**

MUTCD approved on-street bicycle decision sign  
(OR MUTCD Supplement 2009)

## On-Street Bicycle Decision Sign

### *Function and Content:*

Decision signs clarify route options when many are available. Signs typically consist of a system landmark and space for up to three destinations. Decision signs may also include the specific route or path name. A minimum text height of 2 inches per destination should be used, and character width may vary according to destination length. Oregon's supplement to the MUTCD allows adding distance in miles and/or time (10 miles per hour/6 minute per mile travel speed for bicyclists; 3 miles per hour/20 minutes per mile for pedestrians).

Per the MUTCD and Standard Highway Signs, the standard size for a sign that lists destinations in three lines is 18 inches high by 30 inches wide. However, many municipalities use a vertical format sign that measures 24 inches wide by 30 or 36 inches tall. This is accomplished by omitting the bicycle symbol from each separate line and instead having a single symbol at the top of the sign. Generally, providing 6 inches of vertical space per destination line allows for the 2 inch minimum text height. Sign width is not standardized by the MUTCD.

**Table 1: Letter Height Guidance**

	Capital Letter Height	Lowercase Letter Height
Roadway Signage	8 inches	6 inches
Bike Signage	2 inches	1.5 inches

### *Placement:*

Decision signs should be placed before decision making points or intersections. Sufficient distance prior to the intersection (based on design speed, number of destinations, and other sign placement factors) should be provided to allow for safe recognition and response to information provided. Care should be taken so the turns or options the sign refers to are obvious. Decision signs should not be placed near side or access paths that could be confused with the primary route.

Figure 4. Bicycle Turn and Confirmation Signs



MUTCD turn sign

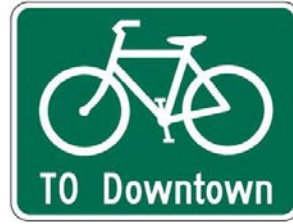

MUTCD confirmation sign

### On-Street Bicycle Turn Sign

#### *Function and Content:*

Turn signs clarify a specific route at changes in direction when only one route option is available. These signs may include a system landmark, route or pathway name, and directional arrow. Standard D1-1 series signs may be used to indicate turns. Turn signs use height and width considerations similar to decision signs. Standard turn arrow signs (M5 and M6 series) may also be used in conjunction with bike route signs to clarify turn movements.

#### *Placement:*

Placement signs are located prior to turns to provide users advance notice of a change in direction. Turn signs may be used in conjunction with a decision sign at complex intersections warranting additional guidance.

### On-Street Bicycle Confirmation Sign

#### *Function and Content:*

Confirmation signs, placed after a turn movement or intersection, reassure users that they are on the correct route. System landmark and/or route name may be included. A minimum size of 24 inches wide by 18 inches high should be used for on-street bike route signs.

#### *Placement:*

Signs should be placed 50 to 100 feet after decision points. Confirmation signs need not occur after every intersection. They should be prioritized at locations where a designated route is not linear and after complex intersections. Complex intersections include those having more than four approaches, non-right angle turns, roundabouts, or in-direct routing.

Figure 5. Bicycle Decision Sign

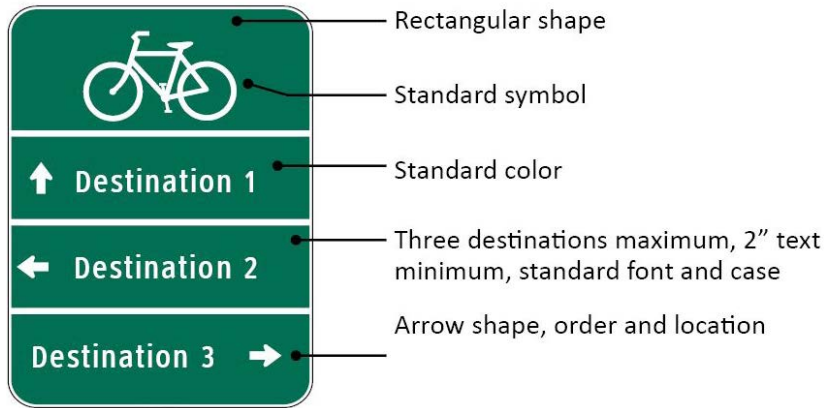

Standard MUTCD compliant decision sign

### National Signage Guidance

The MUTCD specifies the standard for all traffic control devices (including wayfinding signs and pavement markings) installed on any street, highway, bikeway (including paved shared use paths), or private road open to public travel. The MUTCD was established to achieve uniformity and consistency in traffic control devices so information would be readily recognized and understood by travelers. Both on-street and off-street bicycle facilities are required to follow the standards within the MUTCD.

Per the MUTCD, signs should be designed so that:

- Size, shape, color, composition, lighting or retro-reflection, and contrast are combined to draw attention to the sign; simplicity of message combine to produce a clear meaning.
- Legibility and size combine with placement to permit adequate time for response.
- Uniformity, size, legibility, and reasonableness of the message combine to command respect.

Additionally, the MUTCD recommends the arrangement and amount of text, also referred to as legend, on each section of each sign:

- Decision signs should be limited to no more than three lines of destinations, but a single line destination is highly recommended. These include place names, route numbers, street names, and cardinal directions.
- A straight-ahead location should always be placed in the top slot followed by the destination to the left and then the right. If two destinations occur in the same direction, the closer destination should be listed first followed by the farther destination.
- Arrows shall be depicted as shown above for glance recognition, meaning straight and left arrows are to be located to the left of the destination name; while an arrow indicating a destination to the right shall be placed to the right of the destination name. The approved arrow style must be used.
- If limiting the destination name to a single line, the maximum length for a destination title should be 19 characters (including

Figure 6. Typical Sign Placement

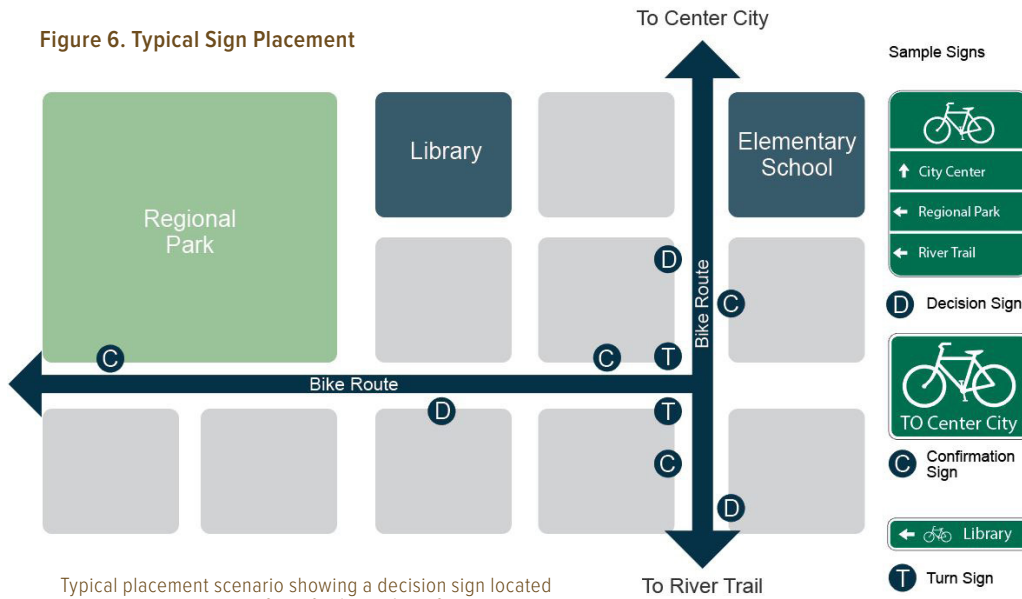

spaces) in title case. An ideal length for a single destination title is 10-14 characters (including spaces) in title case. These character limits often necessitate the use of abbreviations or icons, which are also helpful in serving non-English speaking travelers. Standard icon sets and abbreviations will be provided in the final document.

- In situations where two destinations of equal significance and distance may be properly designated and the two destinations cannot appear on the same sign, the two names may be alternated on successive signs.
- Approved fonts include the Federal Series (series B, C, or D), also known as Highway Gothic. FHWA granted interim approval for use of the Clearview font in 2004, but rescinded this approval in January 2016. A contrast level of 70% needs to be achieved between foreground (text and graphics) and background.

FHWA and USDOT have made statements encouraging a flexible approach in support of facilities for bicycling and walking:

- "...DOT encourages transportation agencies to go beyond the minimum requirements, and proactively provide convenient, safe, and context-sensitive facilities that foster increased use by bicyclists and pedestrians of all ages and abilities, and utilize universal design characteristics..." (2010)
- Federal Highway Administration's (FHWA) support for taking a flexible approach to bicycle and pedestrian facility design. (2013)

While the MUTCD provides standards and guidelines for the design, size, and content of wayfinding signs, many jurisdictions have implemented unique signs to enhance visibility while reinforcing local identity.

Figure 7. MUTCD Spectrum



The MUTCD Spectrum (Fig. 7) shows a range of wayfinding elements that have been implemented by municipalities around the U.S. The range extends from rigid MUTCD on the left to the more flexible options on the right. Signs that adhere to the MUTCD basic minimum standards are readily understood by a wide audience, economical, and simple to fabricate and maintain. Because of their

strict MUTCD compliance, these signs are also clearly eligible to be implemented with federal transportation funding sources. Signs that follow the community wayfinding standards may be costlier to design, fabricate, and maintain, however they have the added benefits of reflecting local character and identity.



Figure 8. Fundamental Wayfinding Elements - On-Street Sign

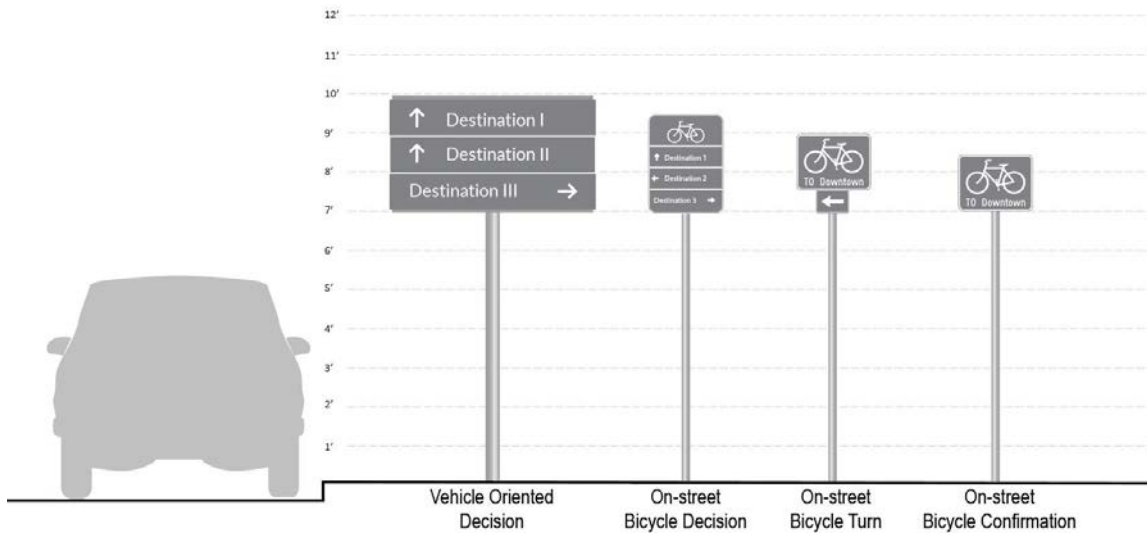

Figure 9. Fundamental Wayfinding Elements - Additional Elements

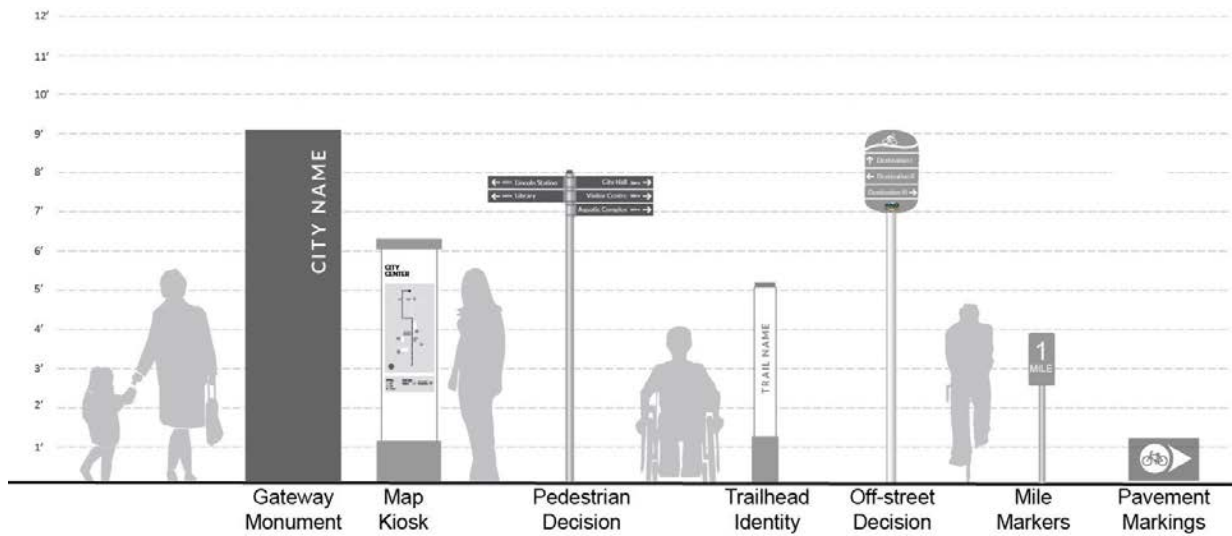
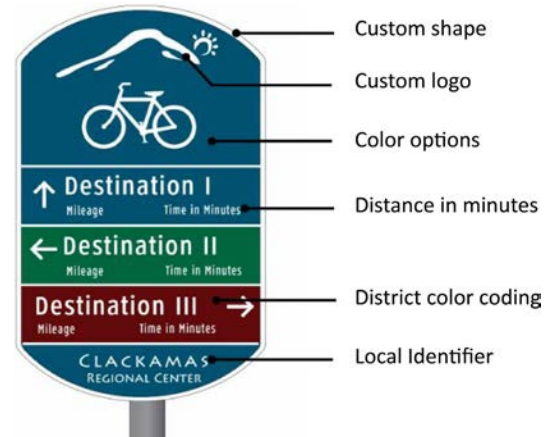

Figure 10. Flexible Decision Sign



Flexible decision sign incorporating community wayfinding standards

## Community Wayfinding Standards

Wayfinding signs, which allow for an expression of community identity and pride, reflect local values and character and may provide more information than signs which strictly follow the basic guidance of Part 9 in the MUTCD. Section 2D.50 of the MUTCD describes community wayfinding signs as follows:

- Community wayfinding guide signs are part of a coordinated and continuous system of signs that direct tourists and other users to key civic, cultural, visitor, and recreational attractions and other destinations within a city or a local urbanized or downtown area.
- Community wayfinding guide signs are a type of destination guide sign with a common color and/or identification enhancement marker for destinations within an overall wayfinding guide sign plan for an area.

The design of the directional arrows provide clarity and are approved by the FHWA (Fig. 10). The standard arrow has been deemed by engineering studies to have superior legibility. Enhancement markers may occupy up to 20% of the sign face on the top or side of the sign.

Figure 11. Color Wheel Diagram

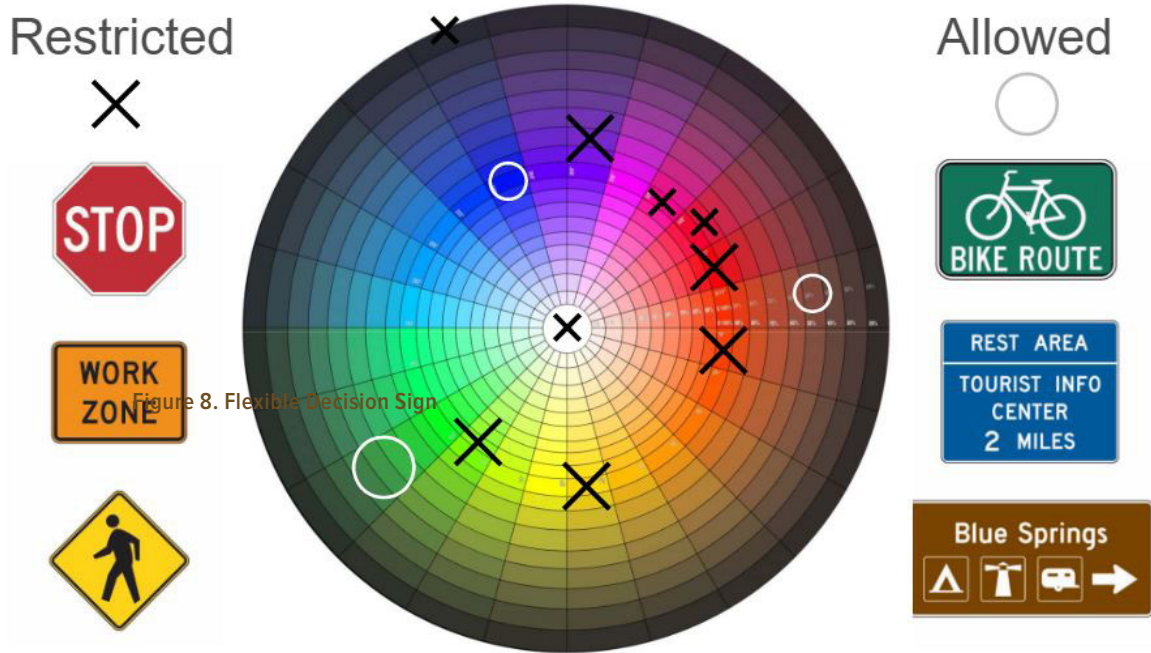

Each of the colors depicted with an "X" are not allowed for use on community wayfinding signs. Colors and the nature of their message is the following: blue (services), brown (recreation), green (guide), orange (construction), pink (incident management), purple (toll roads), red (regulatory), yellow (warning), yellow-green (school zone).

### Colors:

Per the community wayfinding standards, color coding may be used on wayfinding guide signs to help users distinguish between multiple potentially confusing traffic generator destinations located in different neighborhoods or subareas within a community or area. Community wayfinding guide signs may use background colors other than green in order to provide a color identification for the wayfinding destinations by geographical area within the overall wayfinding guide signing system.

The MUTCD prohibits the use of some background colors, known as "assigned colors", for community wayfinding signs to minimize possible confusion with critical, higher-priority regulatory and warning sign color meanings readily understood

by road users. "Assigned colors" consist of the standard colors of red, orange, yellow, purple, or the fluorescent versions thereof, fluorescent yellow-green, and fluorescent pink.

The color wheel diagram (Fig. 11) depicts colors that are already assigned specific meanings and thus shall not be used on community wayfinding signs. Green is the standard color for guide signs. Blue and brown are also used for traveler information including destination and street name signs. The remaining colors are eligible for use on community wayfinding signs as long as they are sufficiently different from "assigned colors".

## Enhanced Navigational Elements

### Pavement Markings

Directional pavement markings indicate confirmation of user presence on a designated route and where users should change direction. Especially in urban settings, pavement markings can often be more visible and can help supplement or reinforce signs.

#### *On-Street Markings*

The following images show different types of pavement markings used for wayfinding purposes. While the shared lane marking (right, top) is currently the only FHWA approved pavement marking, some cities are testing the effectiveness of other options.

In some places in the US, the chevrons on the top of the MUTCD-standard bicycle symbol are used to indicate the direction of intended travel. Although this practice is not approved by the FHWA or eligible for federal funding, many local transportation engineers are confident that the benefits of the turned, directional chevrons outweigh the risks. For example, Portland, OR installs standard shared lane markings with federal funds and then makes modifications later with local funds to add the directional wayfinding component.

#### *Off-Street Markings*

Some pavement markings, including off-street shared use path markings, can give an identity to the route and include directional and trip information, including distances and/or times. While such markings are not included as traffic control devices within the



On-street shared lane marking



Directional shared lane marking (not FHWA approved)



Off-street pavement marking

MUTCD, numerous communities have implemented off-street markings using thermoplastic or other materials. The installation of thermoplastic on concrete trails requires the use of a binder. Other marking materials, such as an epoxy paint, may be more appropriate for this trail surface type.



Mile marker along the Razorback Greenway in Arkansas



Orientation map with color coded districts in Portland, OR.

## Mile Markers

Mile markers assist users by measuring distance traveled along an on-street or off-street facility. Furthermore, mile markers provide emergency response personnel points of reference to identify maintenance needs or locations of emergency events. System brandmark, facility name, and distance information in miles may be included as well as jurisdiction identification.

Mile markers should be placed every 1/4 to 1/2 mile along a route. Point zero should begin at the southernmost and/or westernmost terminus points of a facility. Mile numbering is often reset at zero as a facility crosses a jurisdictional boundary, but regionally-significant facilities may choose continuous numbering.

Although it is ideal to place mile markers on the right-hand side of the path facing bicycle traffic, they may also be installed on one side of a pathway, on a single post, front and back or embedded in the facility surface itself.

## Map Kiosks

Kiosks with area and/or citywide orientation maps can provide helpful navigational information, especially where cyclists and pedestrians may be stopping long enough to digest more information (i.e. transit stations or stops, busy intersections, trail heads). The use of icons and high contrasting colors can make maps comprehensible to a wider audience.

Adding circles that indicate walk and bike times provides encouragement to explore urban areas. Additionally, orienting signs with respect to the audience's view (known as a "heads up orientation") is considered by wayfinding practitioners to be more intuitive than maps where north is at the top.



Lents Town Center gateway in the Lents neighborhood in Portland, OR



Cedar Park Entry Monument in Cedar Park, TX

## Gateway Monuments

A Gateway Monument is typically any freestanding structure or sign that will communicate the name of a local entity. Gateway signs provide the first welcome to visitors while reinforcing community identity, pride, and sense of place. They should be integrated into the greater wayfinding plan in order to create a unified, welcoming, and legible system.

### Gateway Monuments should:

- Be visible from the traveled way and should be placed at the approach into a local entity, to avoid motorist distraction and visual clutter. There should be a maximum of one Gateway Monument.
- Include the officially adopted seal or slogan of the local entity, however this is not required.
- Be located well beyond the clear recovery zone or otherwise placed to minimize the likelihood of being struck by an errant vehicle.
- Be kept clean, free of graffiti, and in good repair. Their care should be incorporated into City maintenance schedules prior to their installation.
- Be developed and placed to require low or no maintenance to minimize exposure of workers and others to potential risks. Protective graffiti resistant coatings should be applied.
- Be composed of materials that are durable for the projected life span of the project.
- Be appropriate to the proposed setting and community context.
- Be in proper size and scale with its surroundings.



Philadelphia pedestrian wayfinding system



Directional sign currently being implemented in Kelowna, British Columbia

## Pedestrian Decision Sign

Pedestrian decision signs can enhance a user's awareness of surrounding destinations by using color to clearly recognize districts and attractions. Expressing the proximity to local destinations encourages locals and visitors to explore and visit historic areas and landmarks.

## Off-street Decision Sign

Directional signs use arrows to point to nearby destinations, especially at intersections where navigational decisions must be made. These signs name the destinations and may also provide the distance to them.

For pedestrians, the placement of directional signs can be more flexible because pedestrians have more time to pause and interpret the sign. Cyclists, who may be riding faster or together with automobile traffic, require directional signs at prescribed distances before a potential decision point so that they can properly position themselves to make a turn.

Off-street decision signs should be placed a minimum of 24 inches from edge of the facility and be mounted at least 4 feet high.



Trail sign along the Razorback Greenway in Arkansas.

### Trail Identity Sign

Trail identity signs can be located at intersections or trailheads to communicate the facility name. A sign blade indicating the name of the off-street facility can also help bring awareness and attention. Signs should meet MUTCD standards. If signs cannot be provided, pavement markings can provide similar information.



Burke-Gilman trail in Seattle, WA



## Wayfinding Sign Placement Guidance

### Wayfinding Placement Logic

A hierarchy of destinations is established in to order consistently select and arrange destination names for inclusion on signs. It is not possible to name all places on signs, therefore a system of prioritization is used to stagger signs along a route.

Developing a wayfinding system follows a process that includes identifying and prioritizing destinations; identifying common routes that link to major destinations; identifying important transfer locations or decision points along these routes; and finally determining the best location to place signage.

The *Guide for the Development of Bicycle Facilities* by the American Association of State Highway Transportation Officials (AASHTO) provides information on the physical infrastructure needed to support bicycling facilities. Most of this guidance applies to off-street facilities as well. The AASHTO Guide largely defers to Part 9 of the MUTCD for basic guidelines related to the design of wayfinding systems.

Additional information provided by AASHTO regarding wayfinding is as follows:

- Many communities find that a wayfinding system as a component of an active transportation network enhances other encouragement efforts, because it provides a visible invitation to new users, while also encouraging current or experienced users to explore new destinations.
- Wayfinding signs should supplement other infrastructure improvements so that conditions are favorable, as signs alone do not improve safety or rider comfort.
- Guide signs may be used to designate continuous routes that may be composed of a variety of facility types and settings.
- Wayfinding guidance may be used to provide connectivity between two or more major facilities, such as a street with bike lanes and/or sidewalks and a shared-use path.
- Wayfinding may be used to provide guidance and continuity in a gap between existing sections of a facility, such as a bike lane or shared-use path.
- Road/path name signs should be placed at all path-roadway crossings to help users track their locations.
- Reference location signs (mile markers) assist path users in estimating their progress, provide a means for identifying the location of emergency incidents, and are beneficial during maintenance activities.

Figure 12. Minimum Clearances on Shared-Use Paths

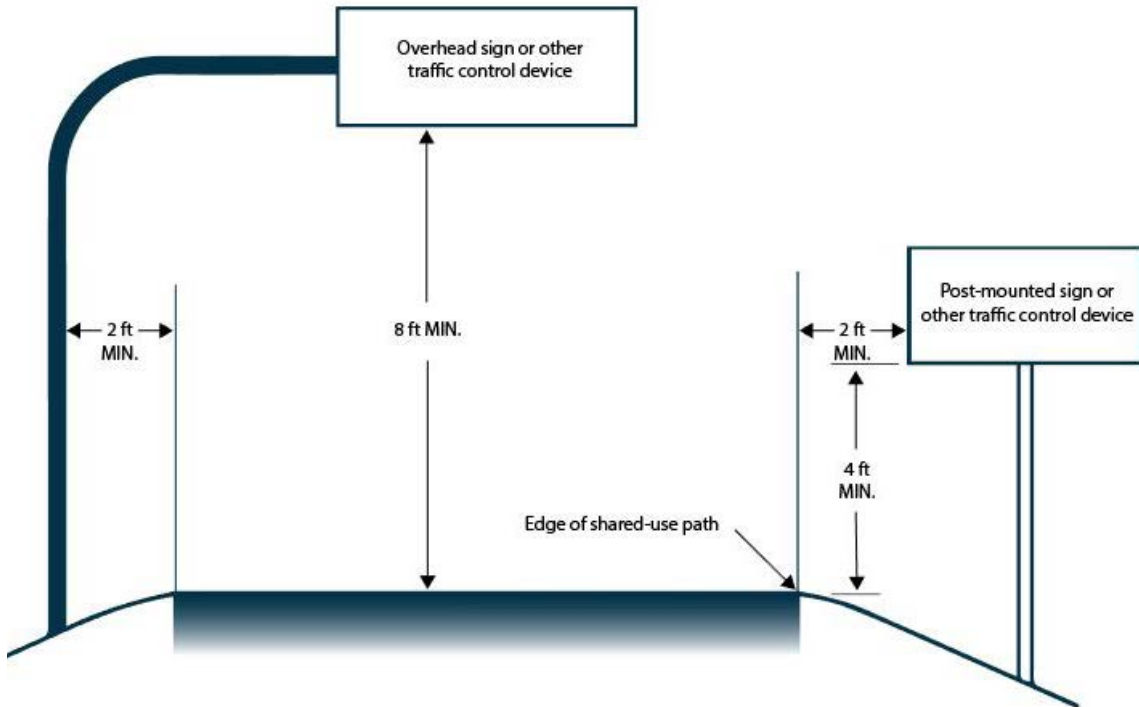

(Source: MUTCD Figure 9B-1)

## Accessibility Standards

As wayfinding systems often relate to accessible routes or pedestrian circulation, it is important to meet technical guidance from the Americans with Disabilities Act 2010 Standards for Accessible Design in order to implement wayfinding elements that do not impede travel or create unsafe situations for those with disabilities.

The following are standards that should be considered when designing and placing wayfinding signs.

## Vertical Clearance

Vertical clearance shall be 96 inches high maximum (when overhanging the an off-street facility), or 48 inches minimum from the grade of the off-street facility to the bottom of the sign and 24 inches from the edge of the facility tread to the edge of the sign when the sign is mounted adjacent to the facility.

Figure 13. ADA Standards Diagrams

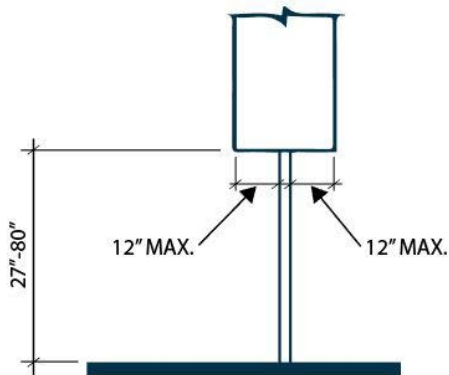

(Source: ADA Standards Figure 307.3)

### Post-Mounted Objects

Where a sign or other obstruction is mounted between posts or pylons and the clear distance between the posts or pylons is greater than 12 inches, the lowest edge of such sign or obstruction shall be 27 inches minimum or 80 inches maximum above the finish floor or ground.

### Protruding Objects

Objects with leading edges more than 27 inches and not more than 80 inches above the finish floor or ground shall protrude 4 inches maximum horizontally into the circulation path.

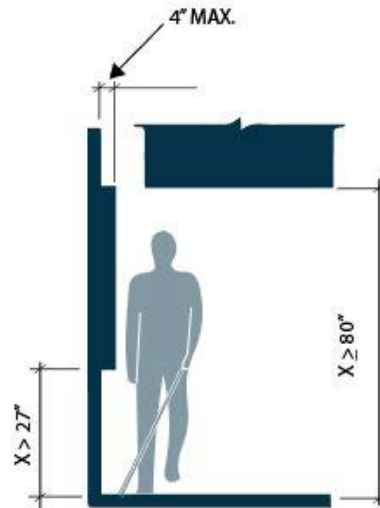

(Source: ADA Standards Figure 307.2)

### Required Clear Width

Protruding objects may not, in any case, reduce the clear width required for accessible routes. Generally, this requirement is met by maintaining 4 feet minimum clear width for people maneuvering mobility devices. This requirement applies to sidewalks and other pedestrian circulation paths.

### Shared Use Paths

Accessibility standards for shared-use paths are being developed by the Architectural and Transportation Barriers Compliance Board (Access Board).



Chapter 4

# Mapping

*A central principle of wayfinding is consistent, easily understood and legible communication of destination names.*

## Destination Hierarchy

There are three types of potential destinations that could be included on signs. Level 1 destinations should receive first priority on wayfinding signs, followed by Level 2. Level 3 destinations should only be included when other destinations are not present to fill available slots on a sign. All destinations to be included on the signs should be open and accessible to the public.

### *Level 1—Districts and Neighborhoods*

Level 1 destinations provide specific navigational information by directing users to recognizable districts and neighborhoods. These may be city centers; historic, commercial, cultural, or educational districts; or neighborhoods with a distinct and recognizable name and character. Emphasis should be placed on districts providing a mix of services. Level 1 destinations should be included on signs up to four miles away.

### *Level 2—Landmarks*

Level 2 destinations are specific landmarks or major attractions which generate a high volume of visitors. Landmarks include transit stations, major

tourist venues, regional parks, open spaces, and post-secondary educational institutions. Level 2 destinations should be signed up to two miles away.

### *Level 3—Local Destinations*

Level 3 destinations are local destinations such as civic buildings, parks, high schools, shopping centers, and healthcare facilities. They typically occur on signs in low-density areas where few other destinations are present or along pathways not connecting higher priority (Level 1 and 2) destinations. Level 3 destinations may be signed up to one mile away.

## Naming Guidance

Sign guidance outlines a standard approach for names of destinations that can reasonably fit on signage. Typically, 14-15 characters (including spaces) is the ideal length for destination names, and 19 characters is roughly the longest that will fit on a sign.

## Approved Destinations

For St. Helens, Level 1 destinations are the Historic District, the Houlton Business District, and the proposed Riverfront District that will be redeveloped in the future. Level 2 destinations are major attractions or landmarks and Level 3 destinations are local attractions.

Table 2 shows the approved destinations, along with the abbreviated name of the destination as it will appear on wayfinding signage.

**Table 2: Approved Destinations**

<b><i>Tier 1 - Neighborhoods &amp; Districts</i></b>	
Tier 1 destinations include neighborhoods and districts of St. Helens that have been identified within City documents. Districts are generally areas that include several destinations which together generate traffic.	
<b><i>NAME</i></b>	<b><i>ABBREVIATION</i></b>
Houlton Business District	Houlton Bus Dist
Riverfront District	Riverfront Dist
St. Helens Downtown Historic District	Historic Dist
<b><i>Tier 2 - Landmarks</i></b>	
Tier 2 destinations are specific landmarks that generate a high amount of interest and travel for visitors and residents alike.	
<b><i>NAME</i></b>	<b><i>ABBREVIATION</i></b>
Grey Cliffs Park	Grey Cliffs Park
Columbia View Park	Columbia View Park
McCormick Park	McCormick Park
McCormick Park Veteran's Memorial	Veteran's Memorial
Campbell Park	Campbell Park
Dalton Lake	Dalton Lake
Nob Hill Nature Park	Nob Hill Park
Eisenschmidt Pool	Pool
Botanical Gardens	Botanical Gardens

City Hall	City Hall
Columbia County Courthouse	Courthouse
County Sheriff's Office & Justice Facility	Sheriff's Office
County Courthouse Plaza	Courthouse Plaza
St. Helens Marina Boat Launch	Boat Launch
Public Docks	Public Docks
St. Helens Public Library	Library
Oregon State Police	State Police
St. Helens Police Station	Police
Fire Station	Fire Station
Legacy Urgent Care Clinic	Urgent Care
Columbia Community Mental Health	CC Mental Health
CC Rider Transit Center	Transit Center
South Columbia County Chamber of Commerce	Chamber of Com
St. Helens Senior Center	Senior Center
Columbia County Fairgrounds	Fairgrounds
Scappoose Bay Marina	Scappoose Bay

### ***Tier 3 - Local Destinations***

Tier 3 destinations are locally important places and receive a tertiary level of priority.

<b><i>NAME</i></b>	<b><i>ABBREVIATION</i></b>
St. Helens High School	High School
St. Helens Middle School	Middle School
Lewis & Clark Elementary School	Lewis & Clark Elem
McBride Elementary School	McBride Elem
Post Office	Post Office
Department of Motor Vehicles	DMV
Columbia River Fire & Rescue Administration Office	Fire Dist. Office
National Guard Armory	Armory
Columbia County Road Department	County Road Dept
Public Health Foundation of Columbia County	Public Health
Columbia County History Museum	History Museum

## Mental Mapping

Exploring how members of a community remember and perceive the built and natural environment is part of the process of developing a wayfinding system. In order to understand common destinations in St. Helens, members of the wayfinding committee were asked to draw a map of St. Helens from memory. Drawing a map from memory reveals the mental or cognitive maps individuals retain of a place, their perceptions of a place, and the locations that are most important to them.

The mental maps of St. Helens (Fig. 14) highlight prominent routes, major landmarks, and city features. Each map is different yet the maps contained many similar defining features of St. Helens.

Highway 30, Old Portland Road/Gable Road, and Columbia Boulevard/St. Helens Street are defining paths into and out of St. Helens. The mental maps confirmed the main nodes as the Historic and the Houlton Districts, where people travel for shopping, dining, civic destinations, and recreation. The City's numerous parks are noted on the mental maps, as are the public docks and waterfront areas.

The Columbia River is also a defining feature as it travels through the region. Major landmarks include the Columbia County Courthouse, City Hall and the St. Helens Public Library. The mental maps help form an understanding of St. Helens. The maps also provide qualitative feedback on the priority destinations list and the route prioritization modeling by confirming important decision points, destinations, and commonly used routes throughout the community.

The following is a list of the common routes and destinations that were detailed in the participants' drawings:

### *Destinations*

- Columbia River
- Columbia County Courthouse
- City Hall
- St. Helens Public Library
- Plaza Square
- St. Helens High School
- St. Helens Middle School
- St Helens Marina
- Walmart (Highway 30 and Gable Road)
- Safeway (Highway 30 and Gable Road)
- Grey Cliffs Waterfront Park
- Columbia View Park
- McCormick Park
- Campbell Park
- Godfrey Park
- Post Office
- DMV

### *Routes*

- Highway 30
- Old Portland Road
- St Helens St.
- 6th Street
- Gable Road
- Columbia Boulevard
- Pittsburg Road
- West Street
- Millard Road



Figure 14. Mental Mapping Exercise Drawings

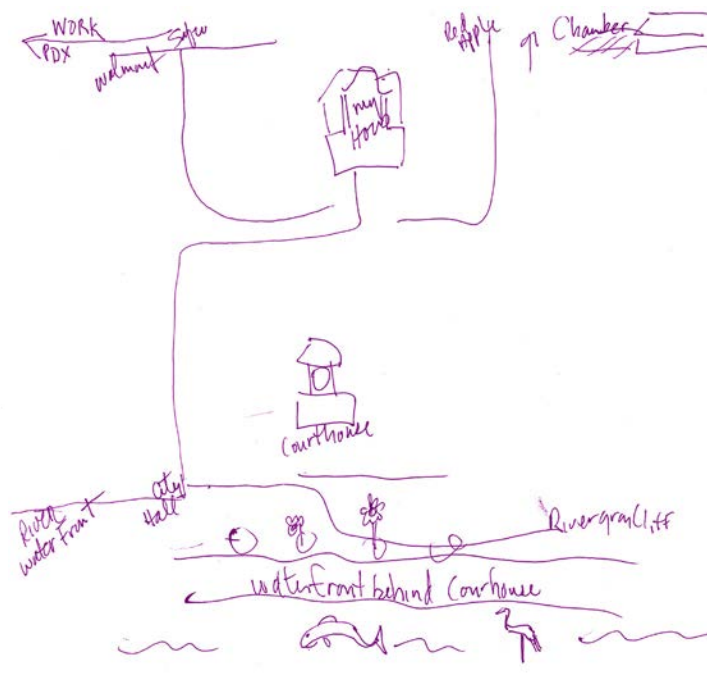
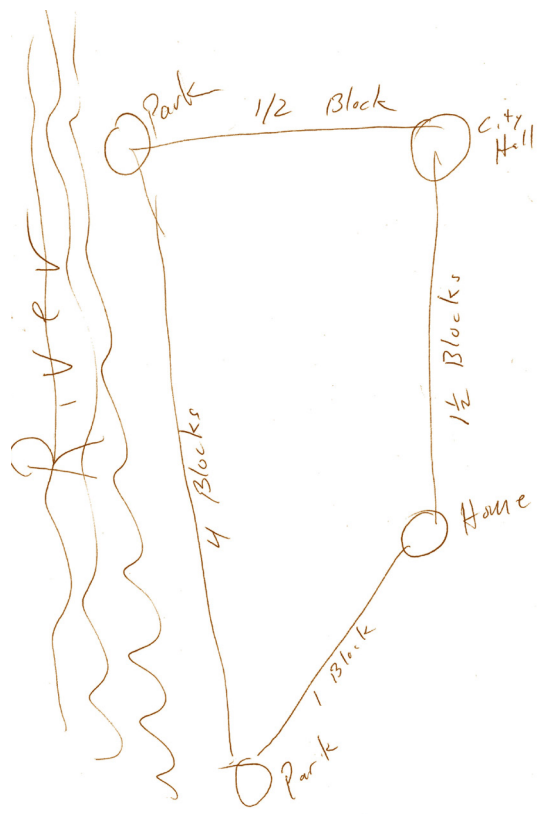
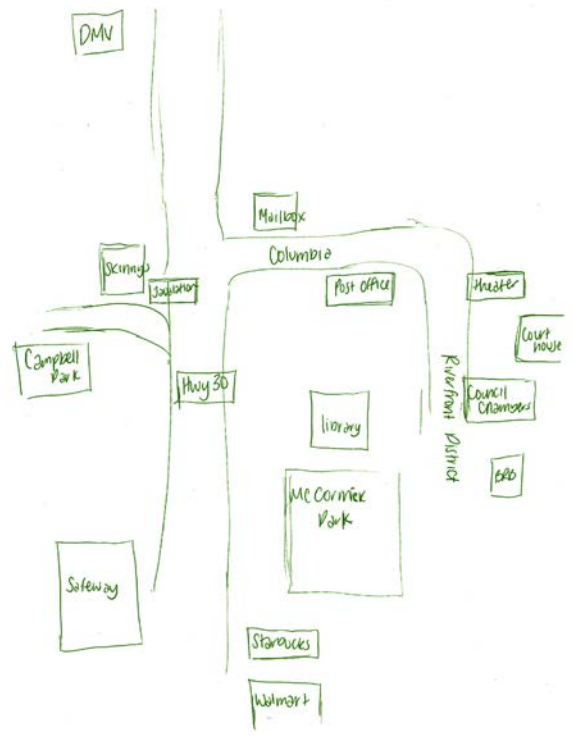
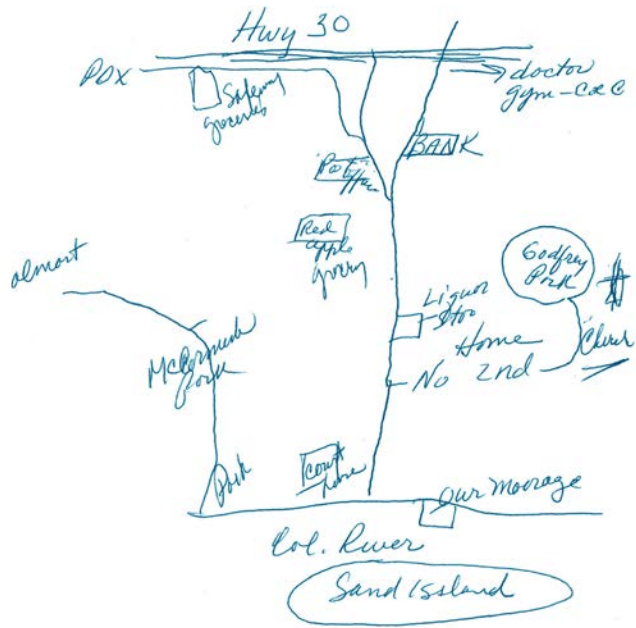

## Sign Placement

Highway 30 and arterial roadways have higher traffic speeds and volumes, and offer important connections to and through St. Helens. Collector roadways and local streets have moderate to lower traffic volume and serve routes within the community. Wayfinding signage and directional signage is located on appropriate or major routes. Pedestrians travel a diversity of routes, all bound by the distance they can comfortably walk.

Decision or access points highlight the logical stages of a journey where travel decisions may be made and where wayfinding information is appropriate.

Map 1 shows the recommended sign placement locations. Bicycle signs are illustrated in dark blue dots, pedestrian signs are illustrated in blue triangles, and vehicle signs are illustrated in red squares.

Vehicular directional signs are not included on Highway 30, as ODOT will not allow vehicular directional signs within the ODOT right of way that differ from MUTCD.

---

Map 1. Sign Placement



0 0.1250.25 MILES



LEGEND

- Bicycle Sign
- ▲ Pedestrian Sign
- Vehicle Sign
- Destination Districts
- Parks

## Route Prioritization

As part of the planning process, routes were prioritized based on route readiness, proximity to destinations, and overall need and gap closure as there relate to navigational challenges in the City. The results of the prioritization process helped to select and prioritize locations for wayfinding improvements. The results are visualized in the initial vehicle route prioritization (Map 2), the initial bicycle route prioritization (Map 3) and the final route prioritization (Map 4).

### Wayfinding Route Prioritization Methodology

A route prioritization score was assigned to each street segment in the project area. The prioritization criteria are based on an analysis of available data in St. Helens and best practices in bicycle wayfinding system design. Applying the criteria to the study area produced two separate scores for each street segment: one for bicycle wayfinding and one for motor vehicle wayfinding. Sufficient data are not available for a quantitative prioritization of pedestrian routes. Therefore, the bicycle prioritization results were adopted and applied to pedestrian routes through a qualitative process.

### Prioritization Criteria

#### *Bicycle Facilities*

Each segment received a score based on the presence of a bicycle facility (existing, planned, or no facility). This criterion only applies to the bicycle wayfinding score. Segments with existing or planned bicycle facilities are a higher priority for bicycle routes and wayfinding.

#### *Proximity to Destinations*

Each segment received a score based on the number (and tier) of destinations within a half mile. The more destinations near the segment, the greater the need for wayfinding improvements. This criterion was weighted higher than the others because the relationship to destinations is a key aspect of wayfinding.

#### *Population and Employment Density*

Each segment received a score based on the number of people who live and work nearby (within 0.25 miles). The population score was drawn from the 2010 Census, at the Census Block level. The employment score was derived from 2014 Longitudinal Employer–Household Dynamics (LEHD) data. A composite score was created by totaling the population and employment scores for each segment. The composite scores were converted to a scale from 2-10, with 10 representing the greatest number of people living and working near the segment.

#### *Houlton and Riverfront District Corridors*

Segments received a score based on their presence within the Houlton and Riverfront District Corridors. The Houlton and Riverfront District Corridors are focus areas for street improvements in the 2015 St. Helens Corridor Master Plan. Segments within these corridors were scored higher for the motor vehicle wayfinding score because of these scheduled infrastructure investments.

Map 2. Initial Motor Vehicle Route Prioritization

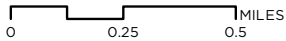
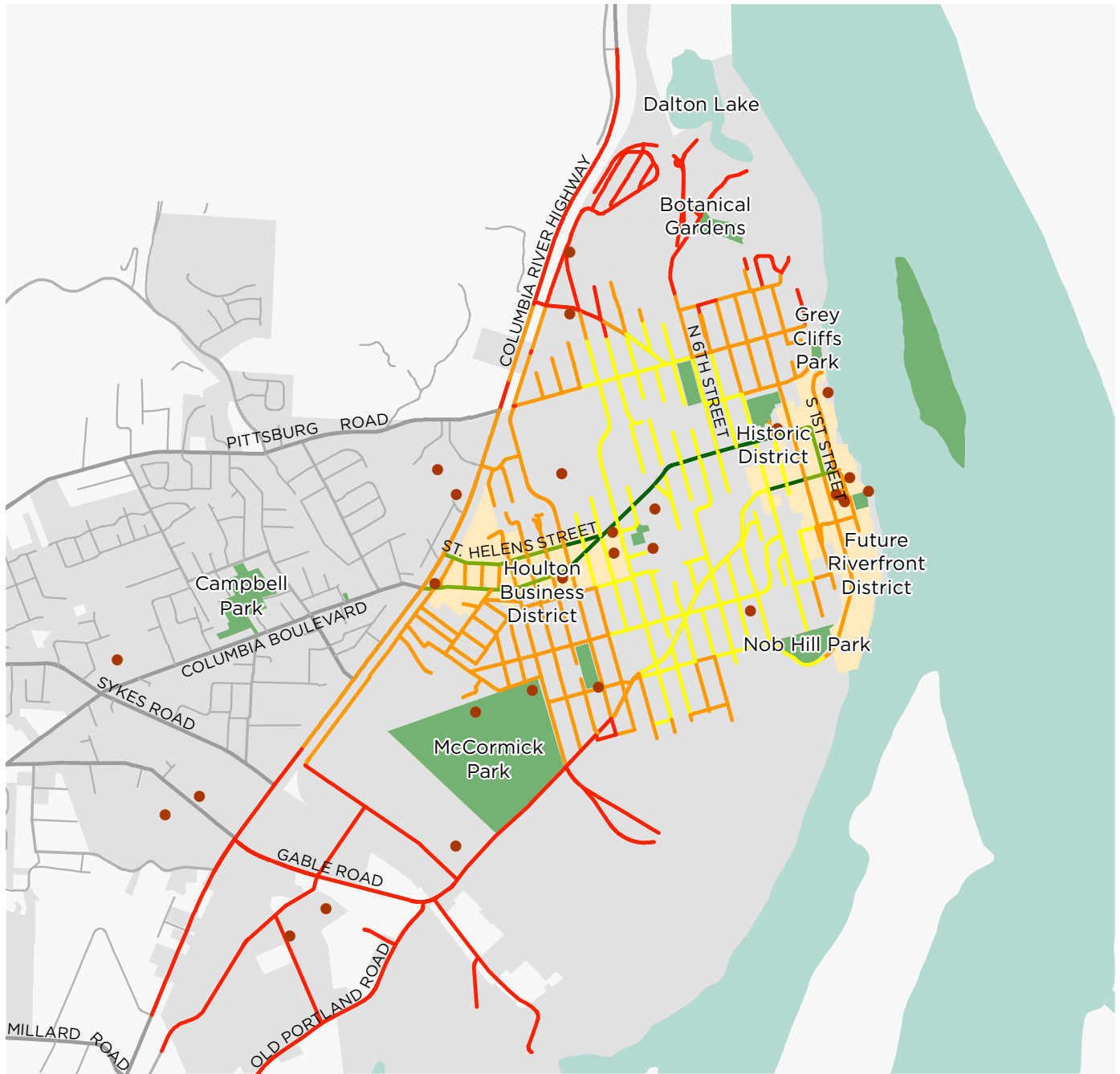

MOTOR VEHICLE PRIORITIZATION SCORE

- 0-20
- 21-25
- 25-30
- 31-35
- 36+

DESTINATIONS

- Points of Interest
- Destination Districts
- Parks

Map 3. Initial Bicycle Route Prioritization

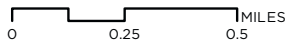

BIKE PRIORITIZATION SCORE

- 0-20
- 21-25
- 26-30
- 31-35
- 36+

DESTINATIONS

- Points of Interest
- Destination Districts
- Parks

Map 4. Final Route Prioritization

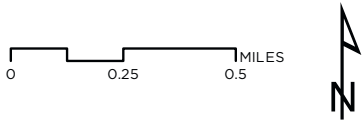

LEGEND

- Primary Route
- Secondary Route
- Points of Interest
- Destination Districts
- Parks



Chapter 5  
Design

*The design incorporated national best practices, community input, local materials, and distinctive architectural details to create a unique wayfinding identity rooted in the history and landscape of St. Helens.*



## Design Process

*Consultation with City staff and community stakeholders provided the design team with valuable information to guide the City of St. Helens Branding and Wayfinding Master Plan.*

A visual preference survey (Fig. 15) was shared with stakeholders to gain a better understanding of the preferred design aesthetic of St. Helens, and the potential direction for the design concepts of the wayfinding sign family.

By asking what words, colors, icons, fonts, typology, materials, and patterns best convey the desired experience and qualities of St Helens, the design team was able to prepare a series of preliminary conceptual designs (Fig. 17-19), which were later finalized into the preferred design (Fig. 20-22).

Figure 15. Visual Identity Preference Activity

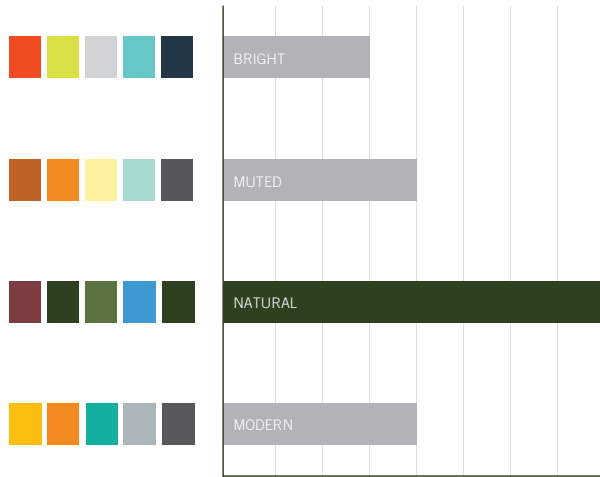

*Color*

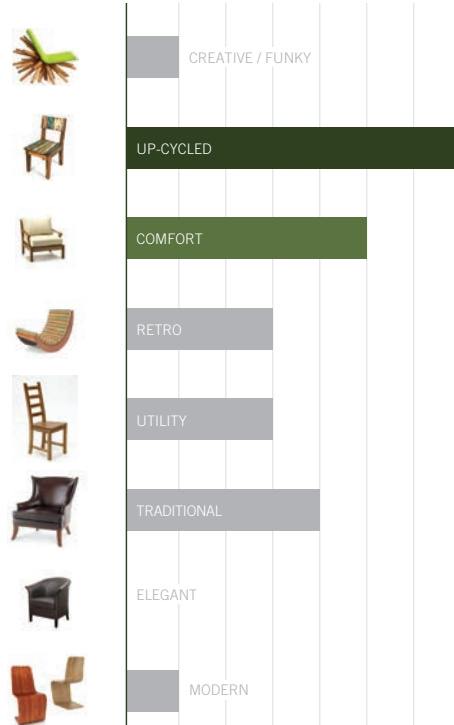

*Typology*



*Materials*

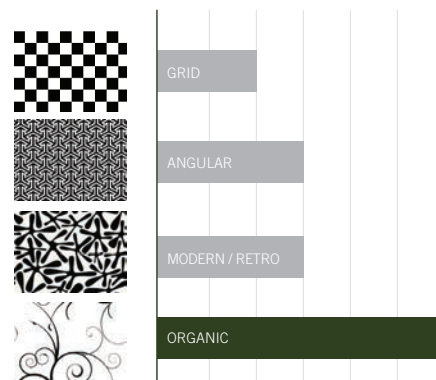

*Pattern*

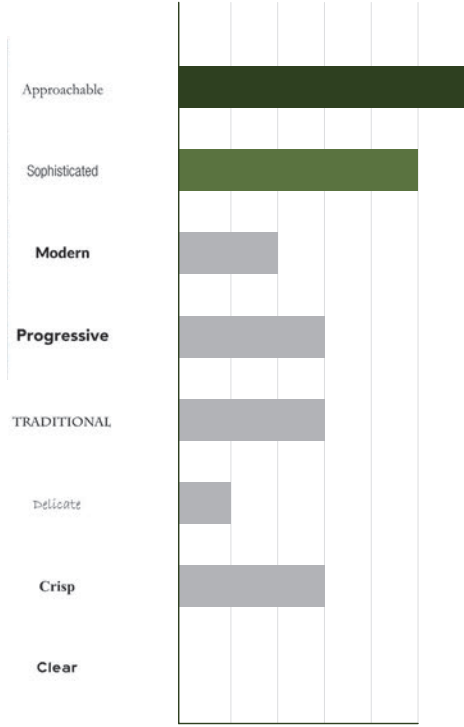

Fonts



Lifestyle

FRIENDLY  
 INVITING  
 PEACEFUL  
 ACCESSIBLE  
 HEALTHY  
 ADVENTURE  
 CONNECTED  
 SAFE  
 ORGANIC  
 RELAXED  
 ENDURING  
 ENERGETIC  
 BOLD  
 FUN  
 EXERCISE  
 SIMPLE

Themes



SENSE OF HISTORY



CONNECTION TO THE COLUMBIA RIVER



LANDMARK ARCHITECTURE

Context

Figure 16. Sketches

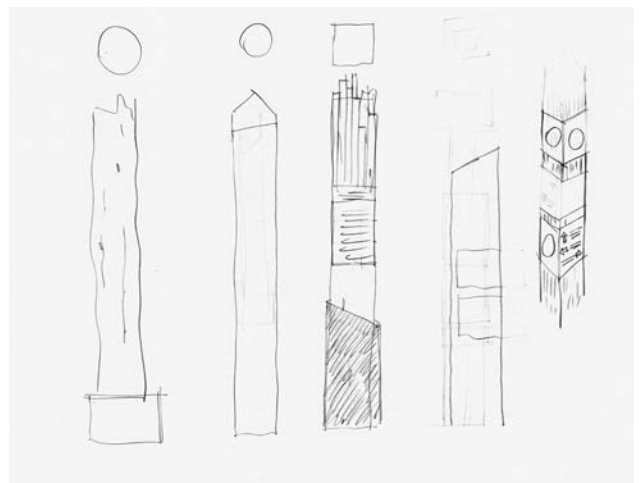
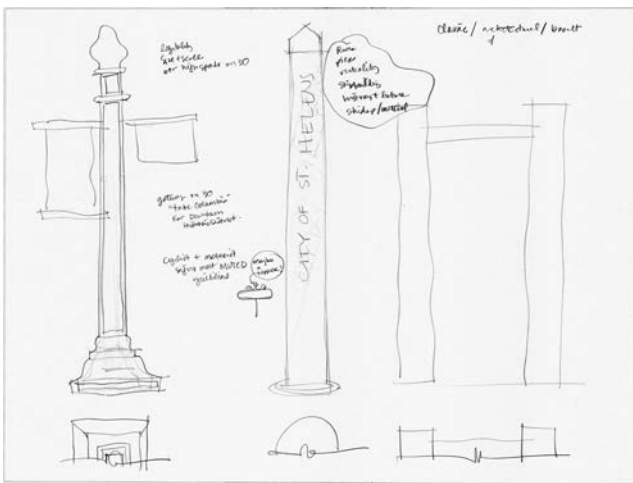
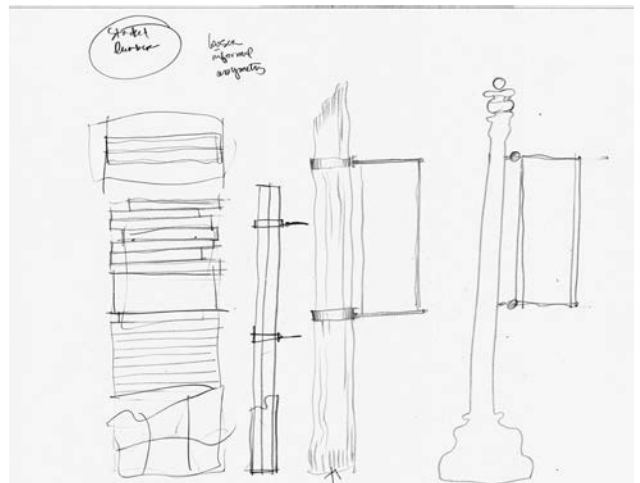
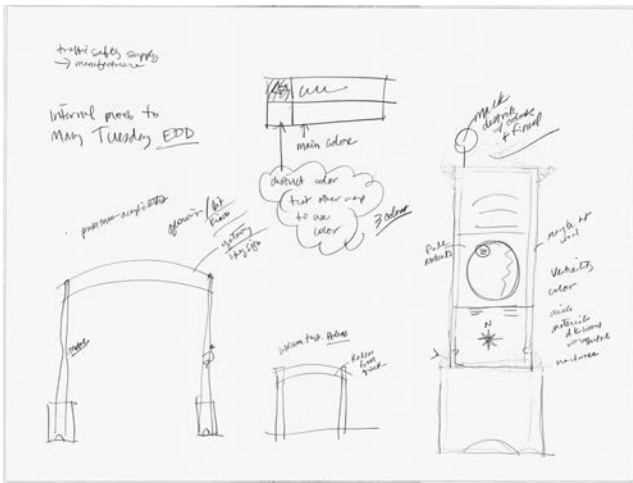
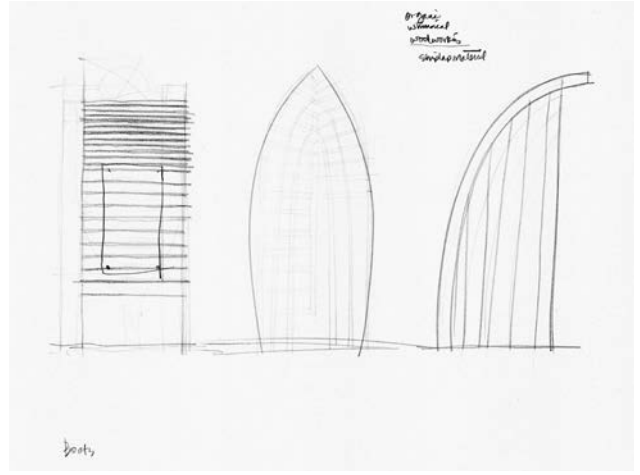
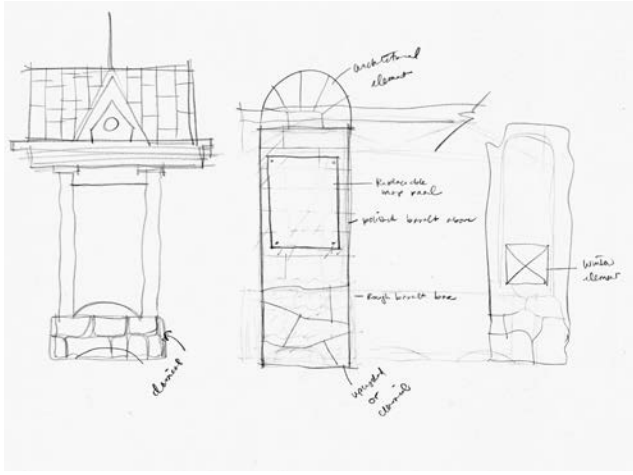

## Design Options

Three design options were developed based on community feedback through the visual preference survey.

### Option 1: Stone

The Stone concept is inspired by the distinctive architectural style of St. Helens historic civic buildings. Local basalt is at the heart of the materials palette, complemented by wood and dark metal. This concept is intended to harmonize with the existing streetscape.

Figure 17. Option 1: Stone

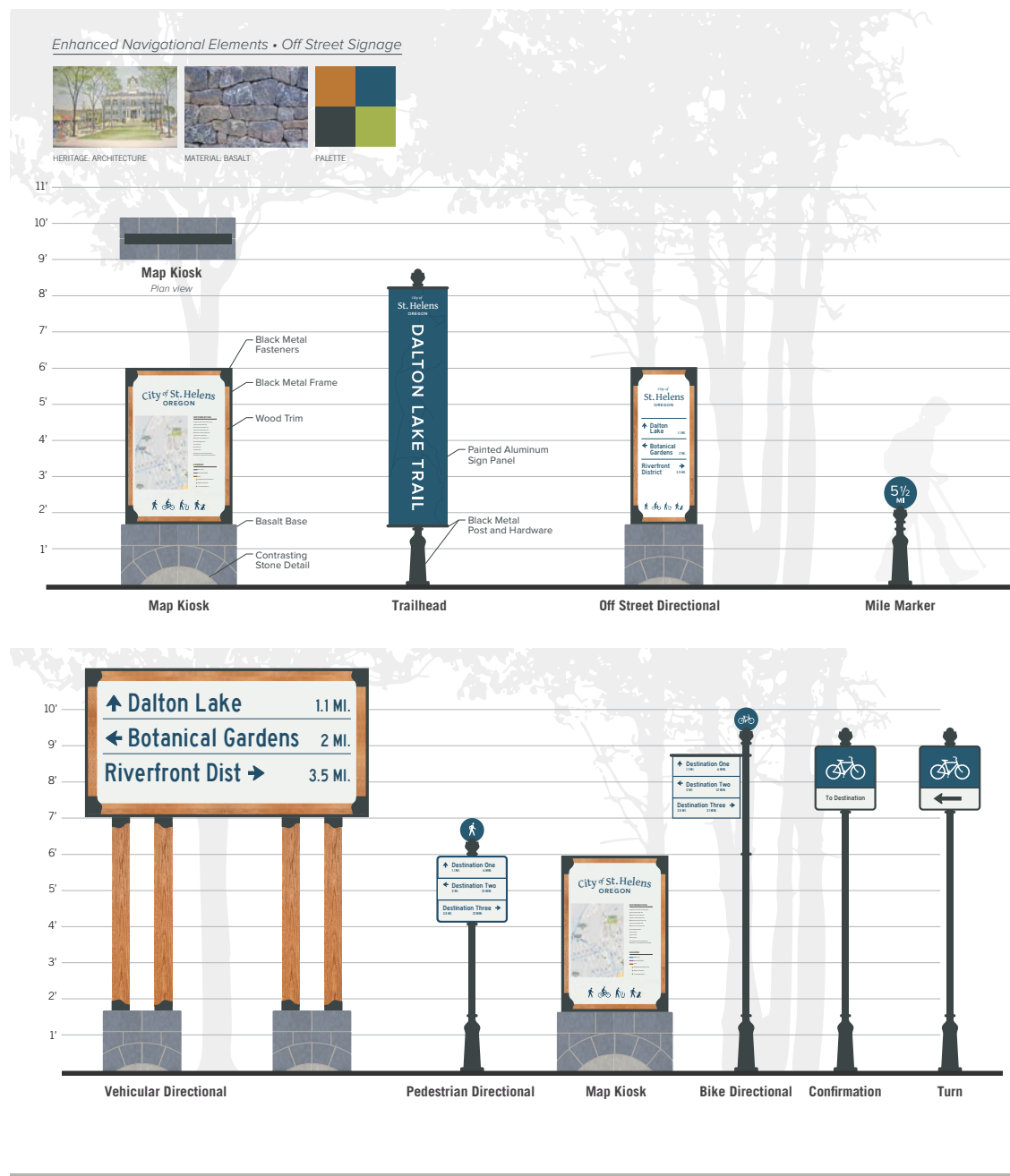

### Option 2: Timber

The Timber concept celebrates St. Helens' history as a lumber mill town and port. The design of the slatted wood signs is based on the sculptural forms of freshly milled lumber stacked for air drying at a lumberyard. Board-formed concrete and a forest-inspired colors round out the palette.

Figure 18. Option 2: Timber

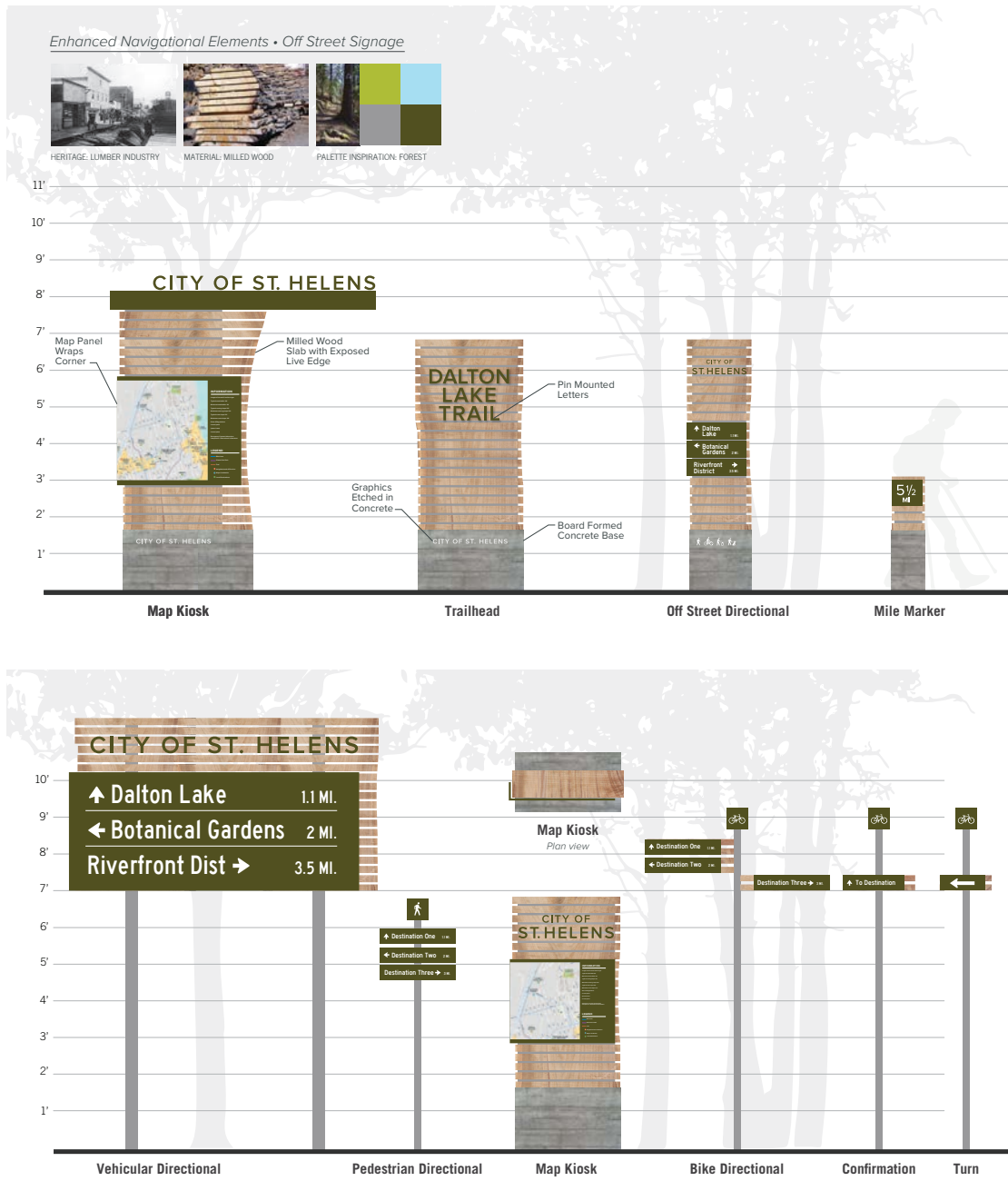

### Option 3: River

The River concept highlights St. Helens' connection to the Columbia and the town's legacy of ship building. The organic forms and light, airy color palette are intended to create an approachable, inviting family of signs.

Figure 19. Option 3: River

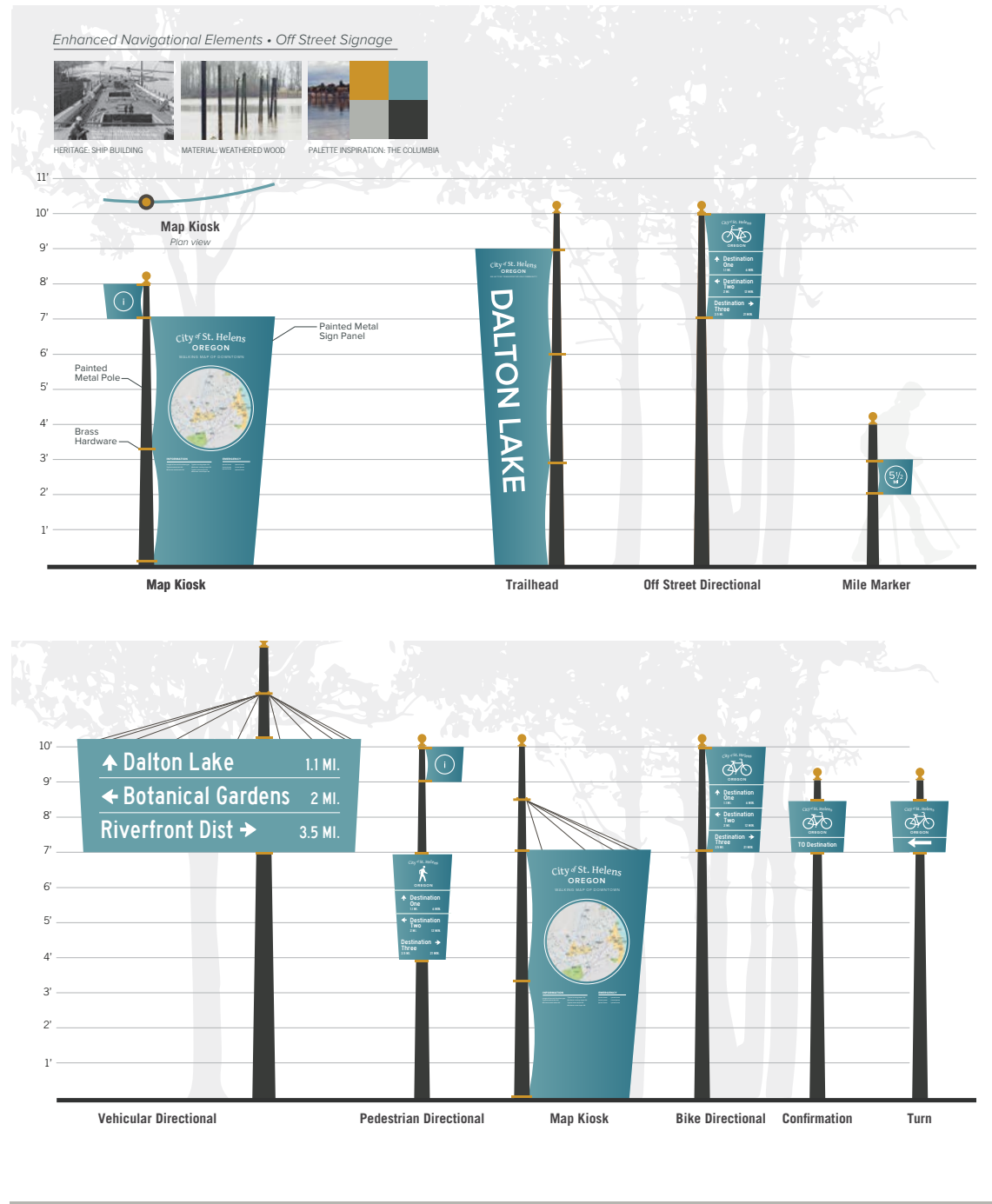

## Preferred Design

Based on community feedback from the three design options, a preferred design was developed.

The family of wayfinding elements for St. Helens will define a sense of place in a way that is clear and simple, reflects local character, and integrates well among other landscape, streetscape, and transportation elements.

The bright, clean, and modern interpretation of a nautical color palette will be used throughout the sign family, with large and legible text. The soft arching wave shape will be used in

the top of the larger signs, with color coded directional arrows and pavement markings used to indicate the district (Fig.20-21). The sign poles are chosen to match the existing, historic light poles in St. Helens (Fig. 21).

The Gateway Arch (Fig. 22), to be placed over Columbia Boulevard, will be constructed of painted aluminum for ease of maintenance.

The wayfinding design elements can be incorporated into facility and other municipal signage, as signs are updated.

Figure 20. Enhanced Navigational Elements - Off Street Signage

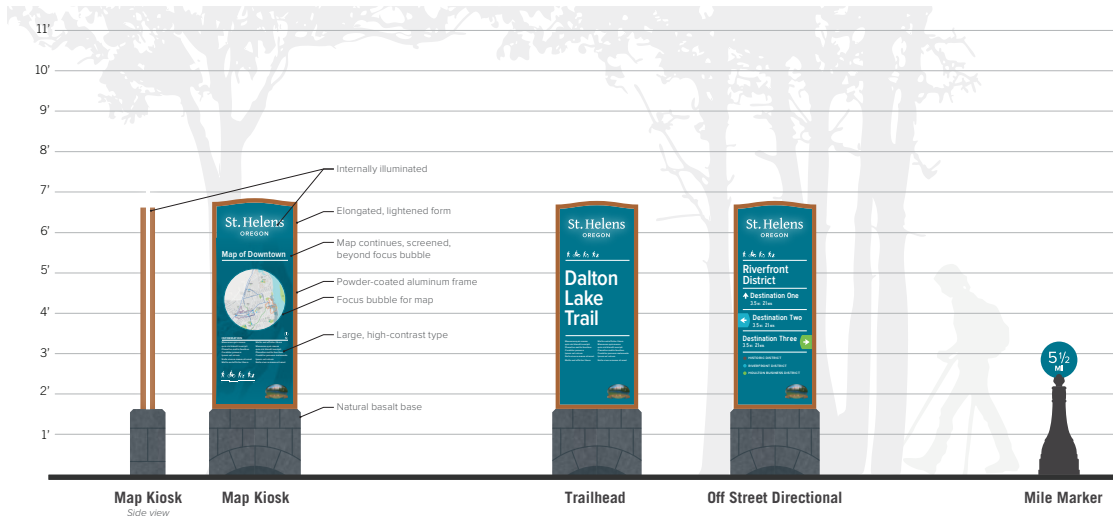



Figure 21. Fundamental Navigational Elements - On Street Signage

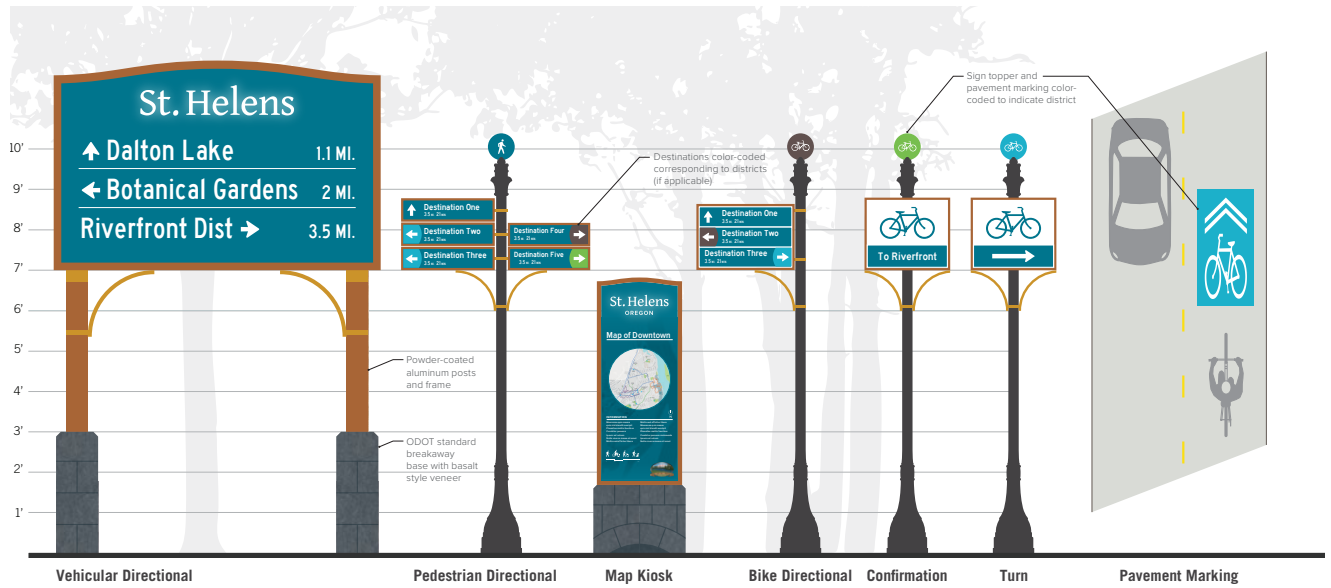
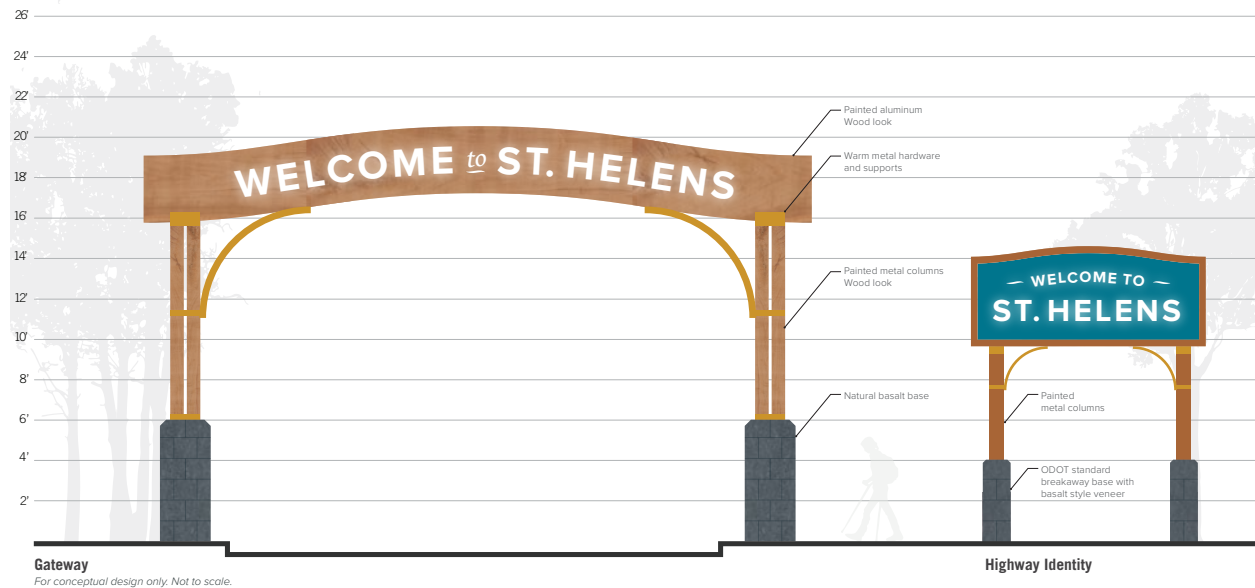

Figure 22. Identity Signage





Chapter 6

# Appendices

## Appendix A: References

### Abbreviations

When placing destination names on signs, the use of abbreviations should be kept to a minimum whenever possible.

When insufficient space is available for full wording, abbreviations may be used. Acceptable abbreviations according to the MUTCD are included below. Unless necessary to avoid confusion, periods,

commas, apostrophes, question marks, ampersands, and other punctuation marks or characters that are not letters or numerals should not be used in any abbreviation.

Word Message	Abbreviation
Alternate	ALT
Avenue	AVE
Bicycle	BIKE
Boulevard	BLVD
Center (as part of a place name)	CTR
Circle	CIR
Court	CT
Crossing (other than highway)	X-ING
Drive	DR
East	E
Hospital	HOSP
Information	INFO
International	INTL

Word Message	Abbreviation
Junction/Intersection	JCT
Mile(s)	MI
Minutes Per Hour	MPH
Minute(s)	MIN
Mount	MT
Mountain	MTN
National	NATL
North	N
Parkway	PKWY
Pedestrian	PED
Place	PL
Road	RD
South	S
Street	ST
Telephone	PHONE
Terrace	TER
Trail	TR
West	W

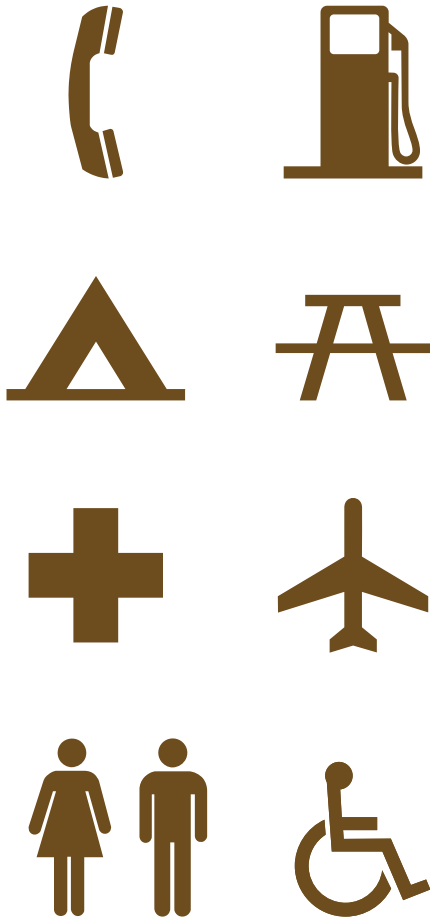

### Icons & Symbols

Icons and symbols can be welcome additions to wayfinding signage design toolkit because they help to communicate information simply and expand comprehension beyond those with English language proficiency. Where proficiency is low, icons and symbols can substitute for words or concepts that are hard to explain or translate, such as trailhead, transit, or school.

Universal symbology and iconography that have been developed by the AIGA (telephone, first aid, toilets), National Park Service (campsite, toilet, scenic view, airport, picnic area), and others (handicap, passenger rail, light rail) are familiar to most people and translate across most languages and cultures.

Use of symbols and icons on wayfinding signage, especially within names of destinations, can save space and improve legibility and comprehension.

## Sources

*Accessibility Standards.* US Access Board, 2012. <http://www.accessboard.gov/guidelines-and-standards>

“Assessment of the Impact of the Indianapolis Cultural Trail: A Legacy of Gene and Marilyn Glick.” Indiana University Public Policy Institute, March, 2015. <http://policyinstitute.iu.edu/uploads/PublicationFiles/15-C02%20CulturalTrail%20Assessment.pdf>

“Design Guidelines for Bicycle Wayfinding.” City of Oakland, CA, 2009.

*Graphic Identity & Sign Guidelines Manual.* Allegheny Trail Alliance and Trail Town Program, August 31, 2008. <http://www.atatrail.org/docs/GAPGuidelines.pdf>

*Guide for the Development of Bicycle Facilities, Fourth Edition.* American Association of State Highway Transportation Officials, 2012.

*Highway Design Manual.* Sixth Edition, 2012. <http://www.dot.ca.gov/hq/oppd/hdm-before-5-7-2012-change/oldhdmtoc.htm>

*Manual on Uniform Traffic Control Devices.* Federal Highway Administration, 2009. <http://mutcd.fhwa.dot.gov/index.htm>

*Manual on Uniform Traffic Control Devices for Streets and Highways: Oregon Supplement to the 2009 Edition.* Federal Highway Administration, 2011. [https://www.oregon.gov/ODOT/HWY/TRAFFIC-ROADWAY/docs/pdf/oregon\\_supplement\\_mutcd\\_2009\\_edition.pdf](https://www.oregon.gov/ODOT/HWY/TRAFFIC-ROADWAY/docs/pdf/oregon_supplement_mutcd_2009_edition.pdf)

*ODOT Traffic Sign Design Manual.* ODOT, Third Edition, 2015. <http://www.oregon.gov/ODOT/HWY/TRAFFIC-ROADWAY/docs/pdf/SignDesignManual.pdf>

*Standard Highway Signs.* Federal Highway Administration, 2012.

“Wayfinding Signs for Shared-Use Paths.” National Committee on Uniform Traffic Control Devices, Spring 2014. <http://www.ncutcdbtc.org/sponsors.html>

United States Access Board. <https://www.access-board.gov/guidelines-and-standards/streets-sidewalks/shared-use-paths/about-this-rulemaking>

## Appendix B: Design Intent









# DESIGN INTENT DRAWINGS

## St. Helens Wayfinding

August 2017



City of St. Helens  
265 Strand Street  
St. Helens, Oregon, 97051

Contact: Jennifer Dimsho, Associate Planner  
Ph: 503.366.8207

### TABLE OF CONTENTS

Graphic Standards	2	Vehicular Directional Sign Detail	11
System Overview	3	On-Street Directional Sign	12
Typical Kiosk	4	On-Street Sign	13
Typical Map Sign Detail	5	Confirmation & Turn Layout	14
Typical Trailhead Sign Detail	6	On-Street Pavement Marking	15
Typical Off-Street Directional Sign Detail	7	Gateway Sign	16
Off-Street Mile Marker	8	Gateway Sign Details	17
Off-Street Pavment Marking	9	Highway Identity Sign	18
Vehicular Directional Sign	10	Highway Identity Sign Details	19

The purpose of these drawings is to illustrate design intent. Drawings are not for construction. Written dimensions on these drawings have precedence over scaled dimensions.

The further development and engineering of these drawings shall be submitted as shop drawings to the Project Owner. Contractors shall verify and be responsible for all final quality, dimensions, materials and conditions on the job.

Project owner shall be notified of any variations from the dimensions and conditions shown by these drawings prior to the execution of any work, including changes to graphic designs or typography.

Drawing scale shown on plans is for full size plans only. Alta shall not be responsible for scale discrepancies caused by reduced or enlarged drawings.











### Alta Planning + Design

711 SE Grand Ave  
Portland, Oregon, 97214  
Ph: 503.230.9862

## MATERIALS PALETTE

Contractor shall be responsible for supplying samples for all colors and materials within the palette.

								
	<b>W</b> White	<b>B</b> Blue	<b>Wr</b> White - Reflective	<b>Br</b> Brown	<b>G</b> Gold	<b>Dg</b> Dark Grey	<b>Lg</b> Light Green	<b>Lb</b> Light Blue
Color:	White	Pantone 2222 C	MP18071	Pantone 168 C	Pantone 1375 C	WBK - Weathered Black	Pantone 3501 C	Pantone 2190 C
Materials:	Matthews Paint	Matthews Paint	3M 3930 High Intensity Retroreflective	Matthews Paint	Matthews Paint	Sternberg Lighting	Matthews Paint	Matthews Paint
Process:	Surface painted, with Matthews Polyurethane Clear Coat Protectant	Surface painted, with Matthews Polyurethane Clear Coat Protectant	Surface painted, with Matthews Polyurethane Clear Coat Protectant	Surface painted, with Matthews Polyurethane Clear Coat Protectant	Surface painted, with Matthews Polyurethane Clear Coat Protectant	Surface painted, with Matthews Polyurethane Clear Coat Protectant	Surface painted, with Matthews Polyurethane Clear Coat Protectant	Surface painted, with Matthews Polyurethane Clear Coat Protectant

## TYPOGRAPHY

Fabricator is responsible for acquiring project related fonts.

Proxima Nova	Aa Bb Cc Dd Ee Ff Gg Hh Ii Jj Kk Ll Mm Nn Oo Pp Qq Rr Ss Tt Uu Vv Ww Xx Yy Zz 1234567890
Gentium Book Basic	Aa Bb Cc Dd Ee Ff Gg Hh Ii Jj Kk Ll Mm Nn Oo Pp Qq Rr Ss Tt Uu Vv Ww Xx Yy Zz 1234567890

## ARTWORK

All artwork illustrated on this page shall be provided by Project Owner as electronic vector art.



City Logo



Arrow



Pedestrian Symbol



Bicycle Symbol



Garbage Receptacle Symbol



Dog Friendly Symbol

**HISTORIC DISTRICT**

**RIVERFRONT DISTRICT**

**HOULTON BUSINESS DISTRICT**

Districts



Sign Accent



Kayaking



Restroom



Food Service



Drinking Fountain



Bike Repair



Biking



Bus Station



Swimming



Hospital



Skateboarding



Trailhead



Hiking

Contractor is responsible for matching all colors and materials as specified and is required to provide color and material sample to the Project Owner for approval.

All painted surfaces to receive Matthews Paint Ultraviolet (UV) and Anti-Graffiti coating. All retroreflective material to receive UV/Anti-Graffiti overlamine, or owner approved equal.

No substitute typefaces will be accepted. Set kerning tracks to visually approximate sign drawings. Kerning shown may vary from exact kerning used to create sign drawings. Refer to specific applications for type sizes and leading requirements.



### GENERAL NOTES

- These drawings are intended to illustrate design intent only and are not for construction. All final engineering and conditions of the project are the responsibility of the fabricator. Shop drawings by the fabricator must be submitted for approval, prior to proceeding with fabrication.
- The quality of fit and finish on the final product must meet or exceed the requirements of these design intent documents. Any variations to design, materials, or fabrication methods must be approved by the Owner or Representative.
- Welds: All welds shall be ground smooth, paint all seams.
- Hardware: All exposed hardware shall be tamper proof fasteners.
- All exposed edges painted to match adjacent face.
- Colors shown are for reference only and are subject to the limitations of the printing process. Refer to referenced color systems contained within these drawings for actual specifications.
- Scaled examples shown are for reference only, and do not necessarily reflect actual site conditions. Detailed site surveys are required prior to fabrication and installation.
- Messages shown in these drawings are for general reference only. Refer to message schedules for actual required messages.

City of St. Helens

CLIENT

St. Helens Wayfinding

PROJECT

August 2017

DOCUMENT ISSUE

Graphic Standards

SHEET TITLE

2

SHEET NUMBER

# SIGNS

## GENERAL NOTES

- These drawings are intended to illustrate design intent only and are not for construction. All final engineering and conditions of the project are the responsibility of the fabricator. Shop drawings by the fabricator must be submitted for approval, prior to proceeding with fabrication.
- The quality of fit and finish on the final product must meet or exceed the requirements of these design intent documents. Any variations to design, materials, or fabrication methods must be approved by the Owner or Representative.
- Welds: All welds shall be ground smooth, paint all seams.
- Hardware: All exposed hardware shall be tamper proof fasteners.
- All exposed edges painted to match adjacent face.
- Colors shown are for reference only and are subject to the limitations of the printing process. Refer to referenced color systems contained within these drawings for actual specifications.
- Scaled examples shown are for reference only, and do not necessarily reflect actual site conditions. Detailed site surveys are required prior to fabrication and installation.
- Messages shown in these drawings are for general reference only. Refer to message schedules for actual required messages.

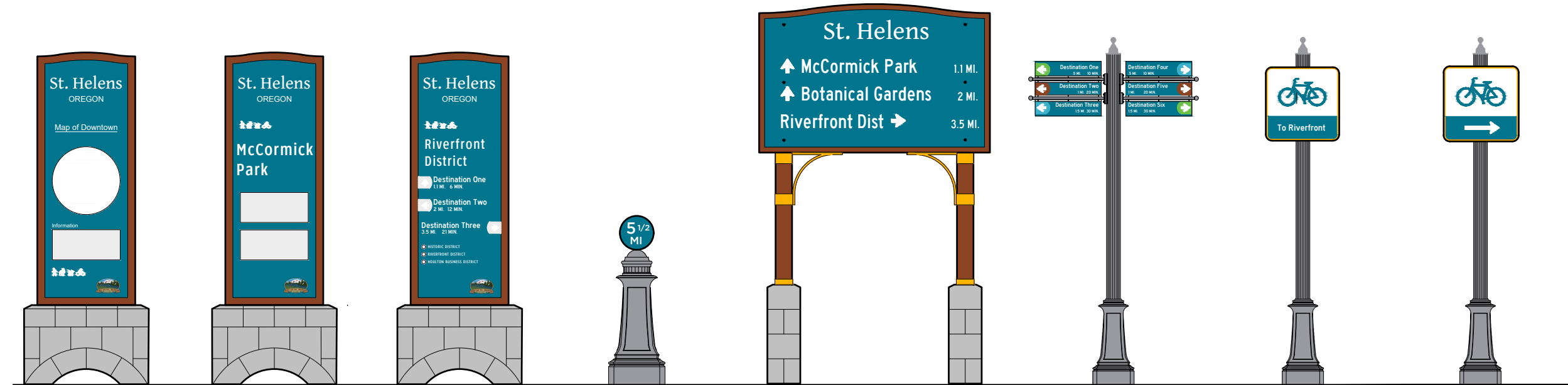

MAP KIOSK

TRAILHEAD KIOSK

OFF-STREET DIRECTIONAL KIOSK

OFF-STREET MILE MARKER

VEHICULAR DIRECTIONAL SIGN

ON-STREET DIRECTIONAL SIGN

ON-STREET CONFIRMATION SIGN

ON-STREET TURN SIGN

## PAVEMENT MARKINGS



GATEWAY SIGN

HIGHWAY IDENTITY SIGN

OFF-STREET PAVEMENT MARKING

ON-STREET PAVEMENT MARKING

City of St. Helens  
CLIENT

St. Helens Wayfinding  
PROJECT

August 2017  
DOCUMENT ISSUE

System Overview  
SHEET TITLE

3  
SHEET NUMBER

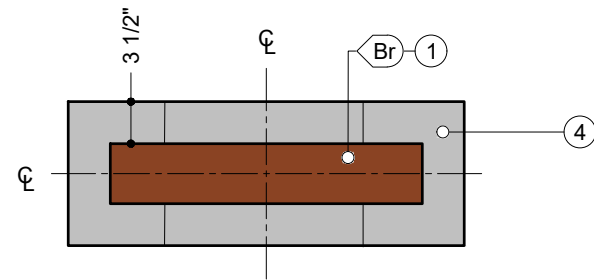

4 Plan View

Scale: 3/4" □ 1'-0"

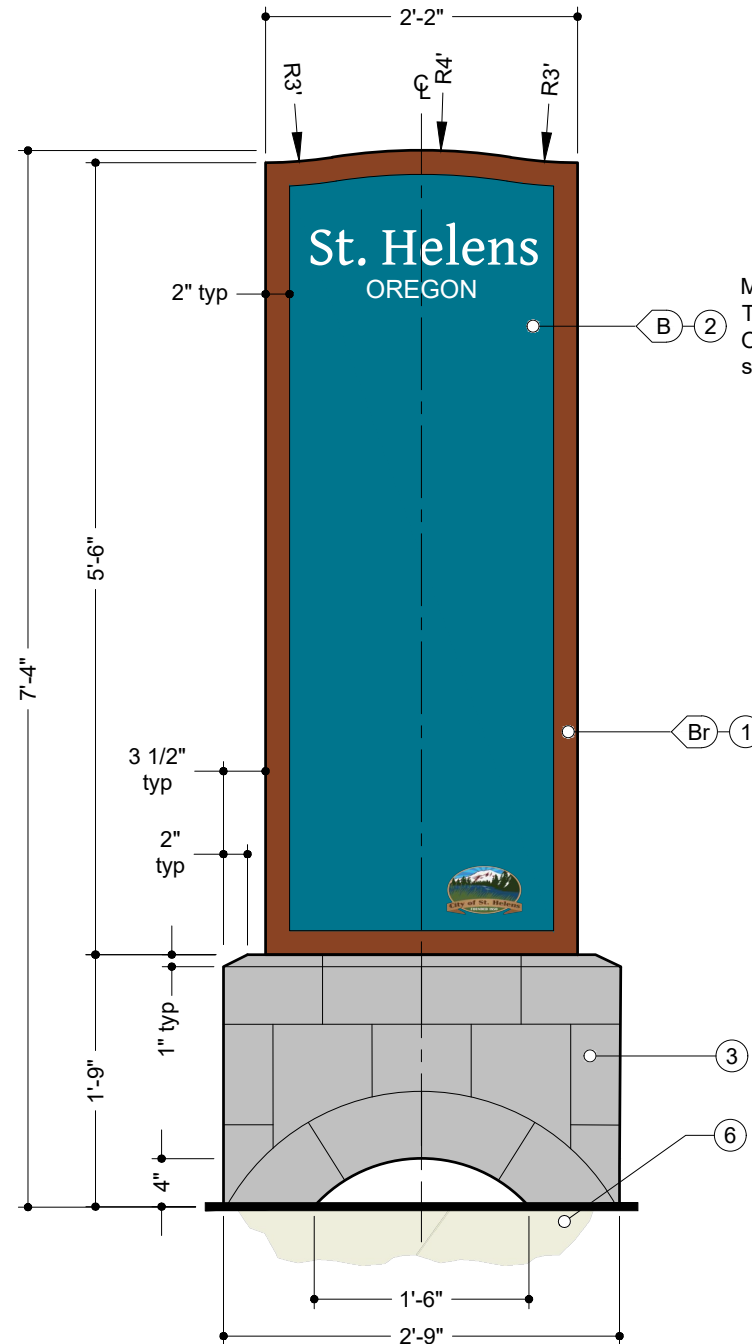

1 Front Elevation

Scale: 3/4" □ 1'-0"

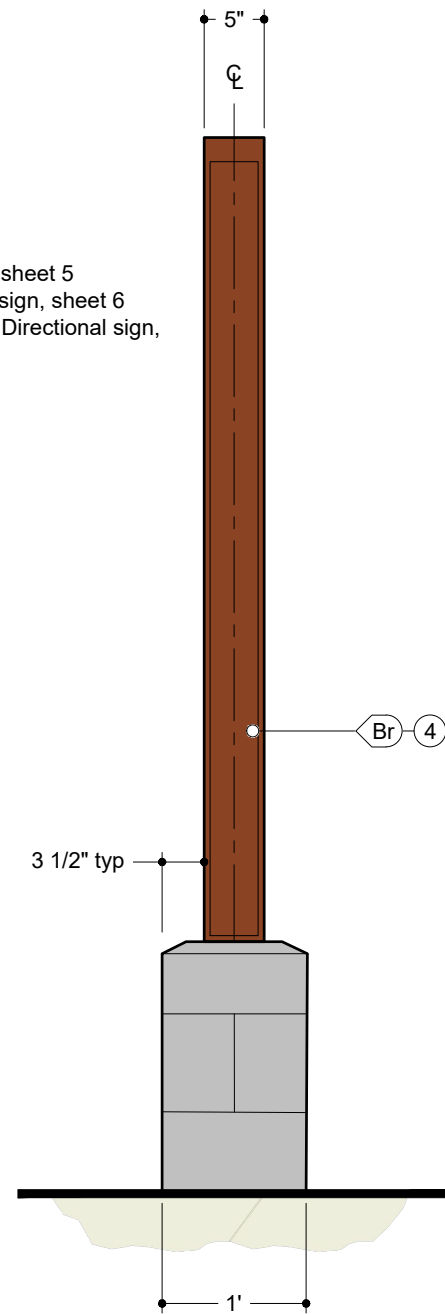

2 Side Elevation

Scale: 3/4" □ 1'-0"

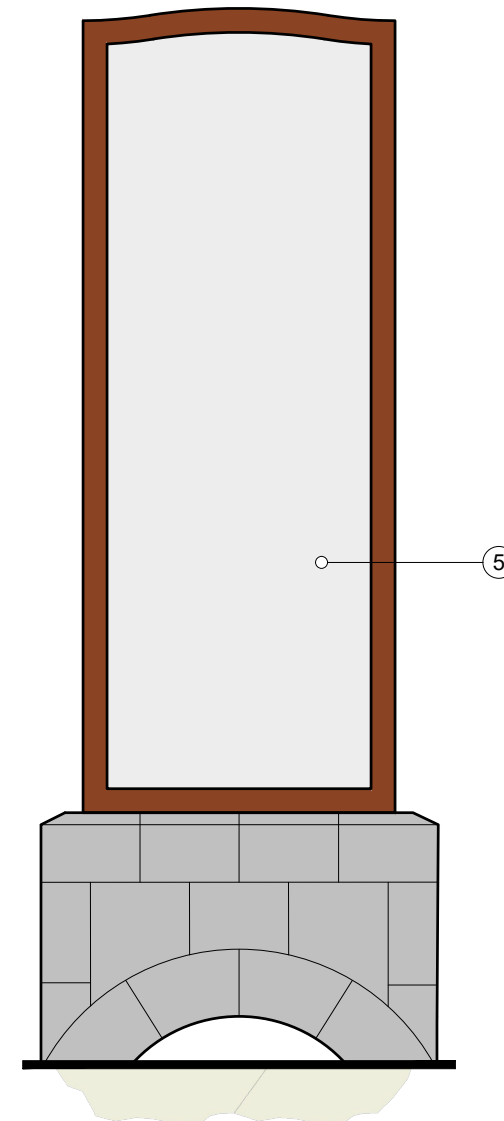

3 Back Elevation

Scale: 3/4" □ 1'-0"

KEY NOTES

1. SIGN CABINET

MATERIAL: 1/8" thick aluminum  
Fabricated from heavy gauge aluminum with aluminum angle internal frame and support cradles. Cabinet is supported by steel tube uprights in concrete footers.

2. SIGN PANEL

MATERIAL: 1/8" thick aluminum  
FABRICATION PROCESS: router cut, internally illuminated  
EDGES: routed, finished smooth  
GRAPHICS/TEXT: screen printed, graphics to be internally lit illuminated with LED backlights mounted to fabricated light tray fixed to internal structure

3. BASALT BASE

SIZE: 2'-9" L x 1'-0" W x 1'-9" H  
MATERIAL: Basalt veneer over CMU / precast concrete

4. SIDE ACCESS PANEL

SIZE: allow for electrical maintenance. Include access on top of sign as required.

5. BULLETIN PANEL

SIZE: 1/8" thick cork  
FABRICATION PROCESS: outdoor, locking and weatherproof 24" x 36" snap frame. Mechanically attach to aluminum panel with hidden fasteners. Display to hold city flyers and public posting information.  
EDGES: routed, finished smooth

6. FOUNDATION (NOT SHOWN)

SIZE: to engineer's specifications



GENERAL NOTES

- These drawings are intended to illustrate design intent only and are not for construction. All final engineering and conditions of the project are the responsibility of the fabricator. Shop drawings by the fabricator must be submitted for approval, prior to proceeding with fabrication.
- The quality of fit and finish on the final product must meet or exceed the requirements of these design intent documents. Any variations to design, materials, or fabrication methods must be approved by the Owner or Representative.
- Welds: All welds shall be ground smooth, paint all seams.
- Hardware: All exposed hardware shall be tamper proof fasteners.
- All exposed edges painted to match adjacent face.
- Colors shown are for reference only and are subject to the limitations of the printing process. Refer to referenced color systems contained within these drawings for actual specifications.
- Scaled examples shown are for reference only, and do not necessarily reflect actual site conditions. Detailed site surveys are required prior to fabrication and installation.
- Messages shown in these drawings are for general reference only. Refer to message schedules for actual required messages.

City of St. Helens

CLIENT

St. Helens Wayfinding

PROJECT

August 2017

DOCUMENT ISSUE

Typical Kiosk

SHEET TITLE

4

SHEET NUMBER

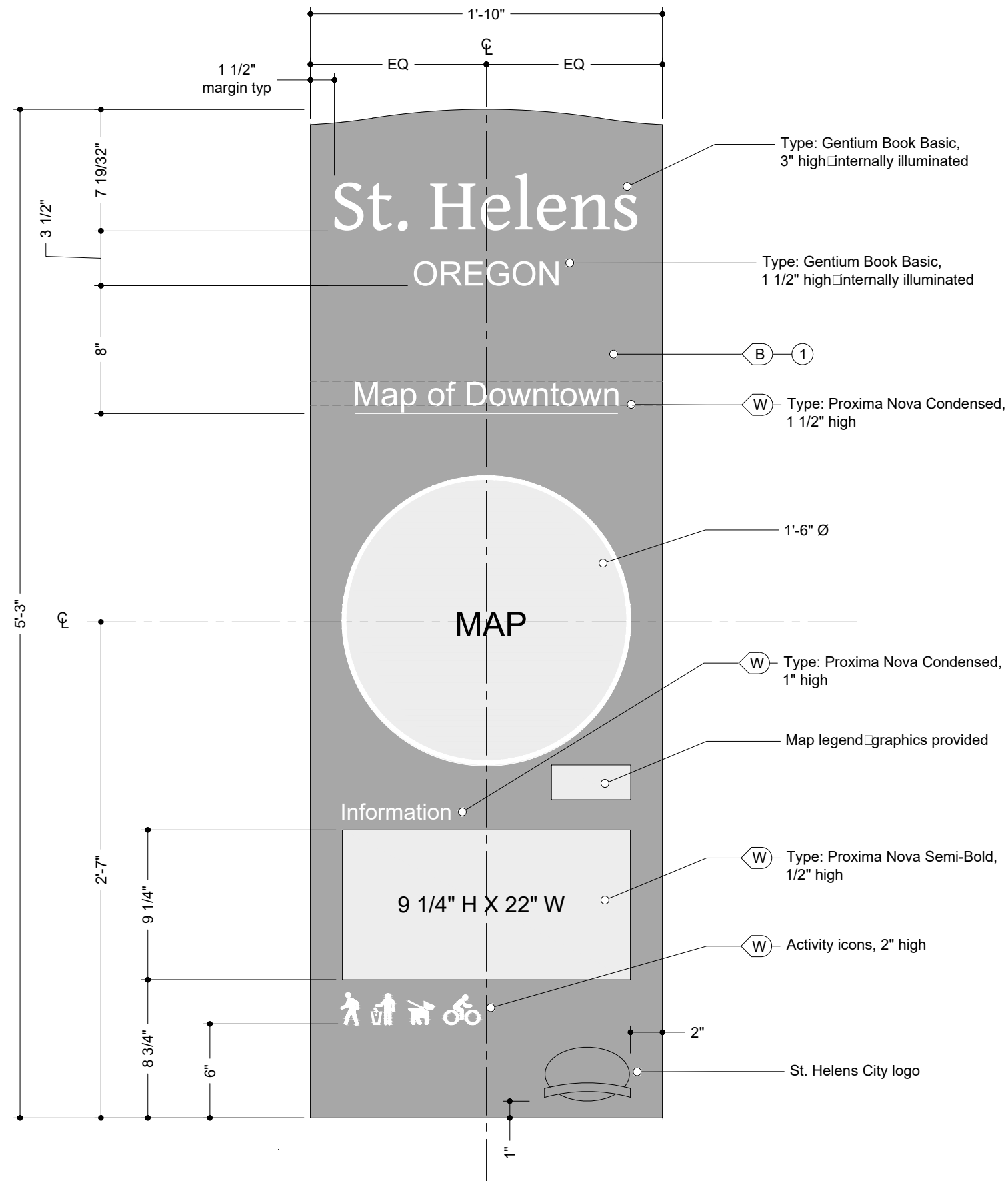

1 Typical Sign Detail  
Scale: 1 1/2" □ 1'-0"

KEY NOTES

- 1. SIGN PANEL**  
 MATERIAL: 1/8" thick aluminum  
 FABRICATION PROCESS: router cut, internally illuminated  
 EDGES: routed, finished smooth  
 GRAPHICS/TEXT: screen printed, graphics to be internally lit illuminated with LED backlights mounted to fabricated light tray fixed to internal structure



GENERAL NOTES

- These drawings are intended to illustrate design intent only and are not for construction. All final engineering and conditions of the project are the responsibility of the fabricator. Shop drawings by the fabricator must be submitted for approval, prior to proceeding with fabrication.
- The quality of fit and finish on the final product must meet or exceed the requirements of these design intent documents. Any variations to design, materials, or fabrication methods must be approved by the Owner or Representative.
- Welds: All welds shall be ground smooth, paint all seams.
- Hardware: All exposed hardware shall be tamper proof fasteners.
- All exposed edges painted to match adjacent face.
- Colors shown are for reference only and are subject to the limitations of the printing process. Refer to referenced color systems contained within these drawings for actual specifications.
- Scaled examples shown are for reference only, and do not necessarily reflect actual site conditions. Detailed site surveys are required prior to fabrication and installation.
- Messages shown in these drawings are for general reference only. Refer to message schedules for actual required messages.

City of St. Helens

CLIENT

St. Helens Wayfinding

PROJECT

August 2017

DOCUMENT ISSUE

Typical Map Sign Detail

SHEET TITLE

5

SHEET NUMBER

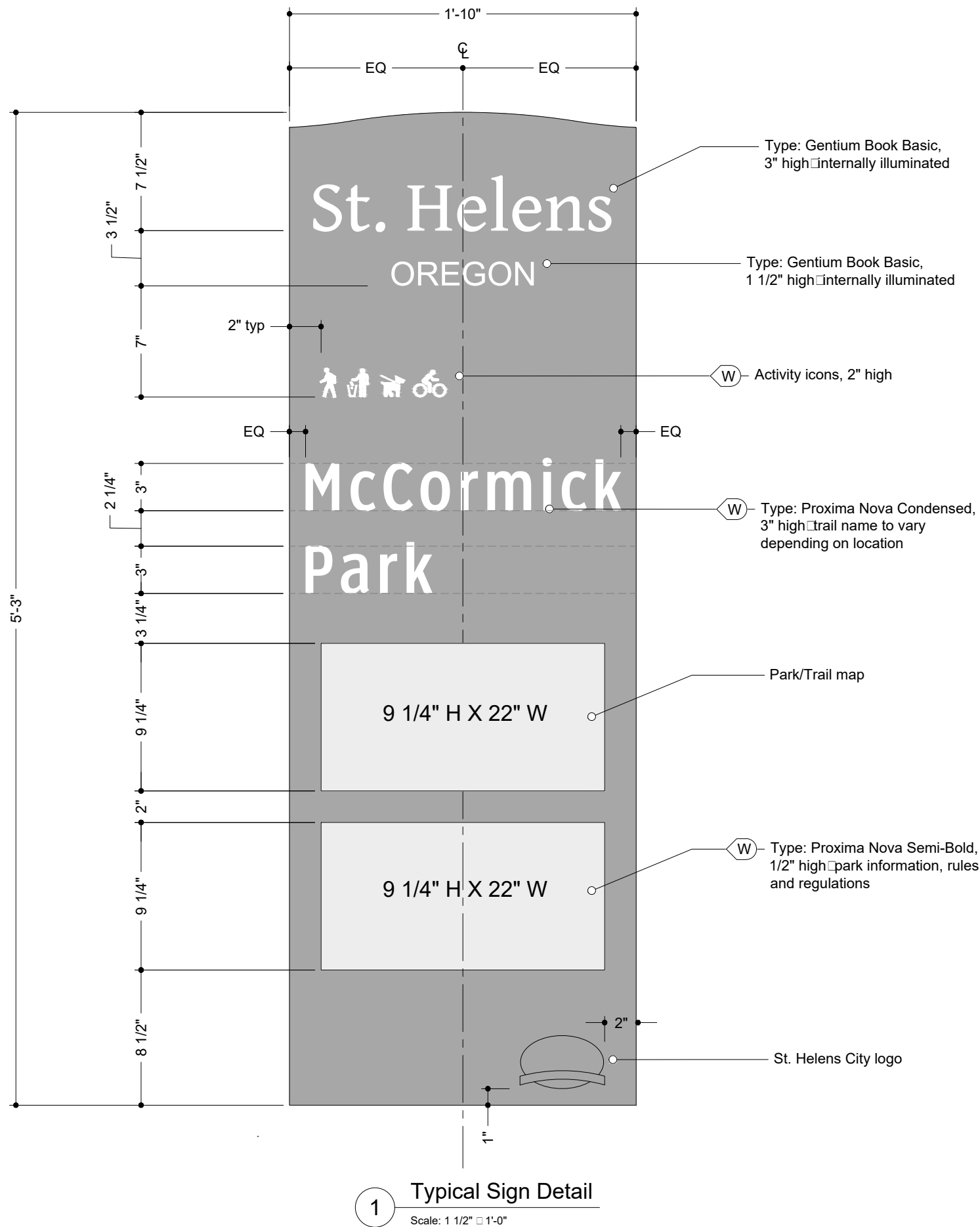

KEY NOTES

1. SIGN PANEL

MATERIAL: 1/8" thick aluminum  
 FABRICATION PROCESS: router cut, internally illuminated  
 EDGES: routed, finished smooth  
 GRAPHICS/TEXT: screen printed, graphics to be internally lit illuminated with LED backlights mounted to fabricated light tray fixed to internal structure



GENERAL NOTES

- These drawings are intended to illustrate design intent only and are not for construction. All final engineering and conditions of the project are the responsibility of the fabricator. Shop drawings by the fabricator must be submitted for approval, prior to proceeding with fabrication.
- The quality of fit and finish on the final product must meet or exceed the requirements of these design intent documents. Any variations to design, materials, or fabrication methods must be approved by the Owner or Representative.
- Welds: All welds shall be ground smooth, paint all seams.
- Hardware: All exposed hardware shall be tamper proof fasteners.
- All exposed edges painted to match adjacent face.
- Colors shown are for reference only and are subject to the limitations of the printing process. Refer to referenced color systems contained within these drawings for actual specifications.
- Scaled examples shown are for reference only, and do not necessarily reflect actual site conditions. Detailed site surveys are required prior to fabrication and installation.
- Messages shown in these drawings are for general reference only. Refer to message schedules for actual required messages.

City of St. Helens

CLIENT

St. Helens Wayfinding

PROJECT

August 2017

DOCUMENT ISSUE

Typical Trailhead Sign Detail

SHEET TITLE

6

SHEET NUMBER

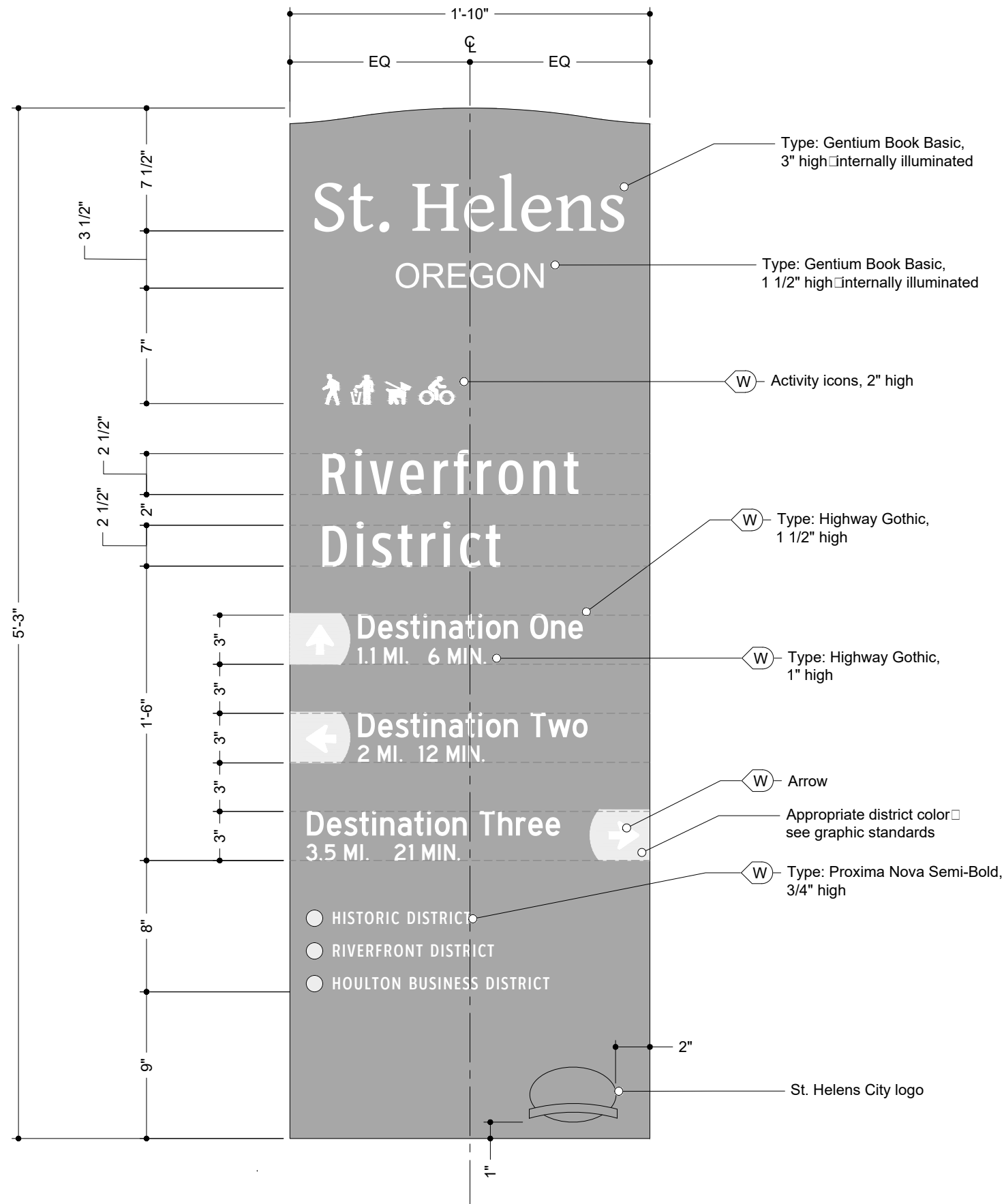

1 Typical Sign Detail  
Scale: 1 1/2" □ 1'-0"

KEY NOTES

1. SIGN PANEL

MATERIAL: 1/8" thick aluminum  
 FABRICATION PROCESS: router cut, internally illuminated  
 EDGES: routed, finished smooth  
 GRAPHICS/TEXT: screen printed, graphics to be internally lit illuminated with LED backlights mounted to fabricated light tray fixed to internal structure



GENERAL NOTES

- These drawings are intended to illustrate design intent only and are not for construction. All final engineering and conditions of the project are the responsibility of the fabricator. Shop drawings by the fabricator must be submitted for approval, prior to proceeding with fabrication.
- The quality of fit and finish on the final product must meet or exceed the requirements of these design intent documents. Any variations to design, materials, or fabrication methods must be approved by the Owner or Representative.
- Welds: All welds shall be ground smooth, paint all seams.
- Hardware: All exposed hardware shall be tamper proof fasteners.
- All exposed edges painted to match adjacent face.
- Colors shown are for reference only and are subject to the limitations of the printing process. Refer to referenced color systems contained within these drawings for actual specifications.
- Scaled examples shown are for reference only, and do not necessarily reflect actual site conditions. Detailed site surveys are required prior to fabrication and installation.
- Messages shown in these drawings are for general reference only. Refer to message schedules for actual required messages.

City of St. Helens

CLIENT

St. Helens Wayfinding

PROJECT

August 2017

DOCUMENT ISSUE

Typical Off-Street Directional Sign Detail

SHEET TITLE

7

SHEET NUMBER

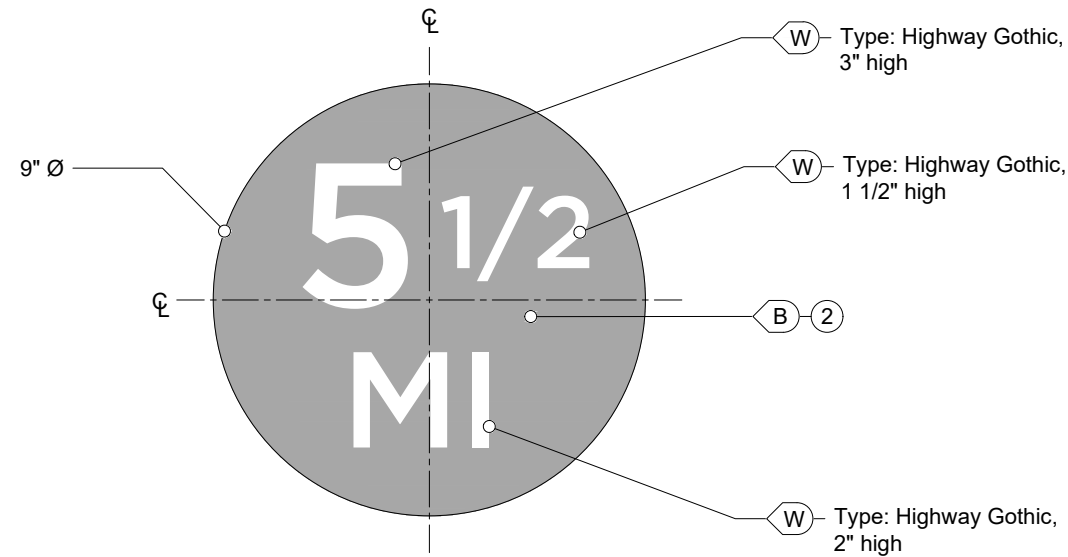

**3** Typical Sign Detail  
Scale: 3" □ 1'-0"

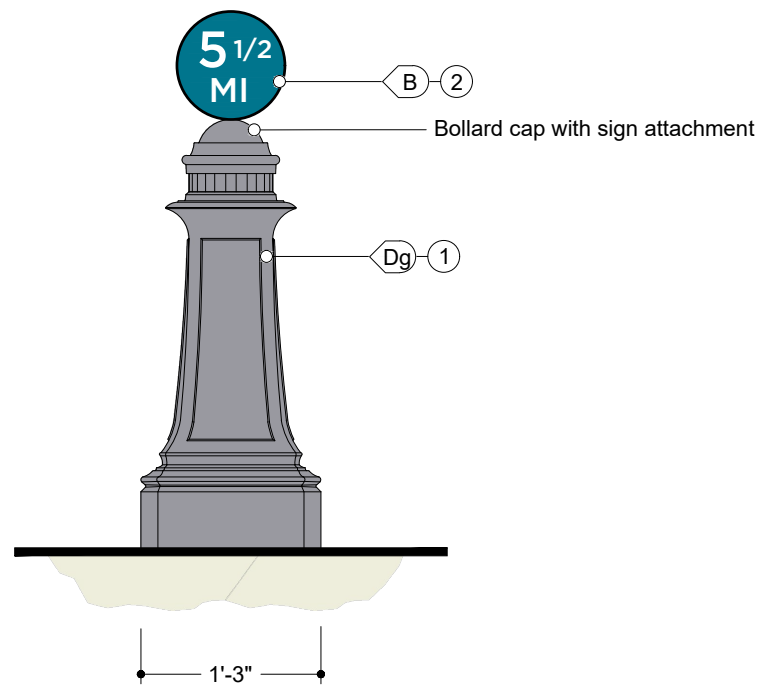

**1** Front Elevation  
Scale: 3/4" □ 1'-0"

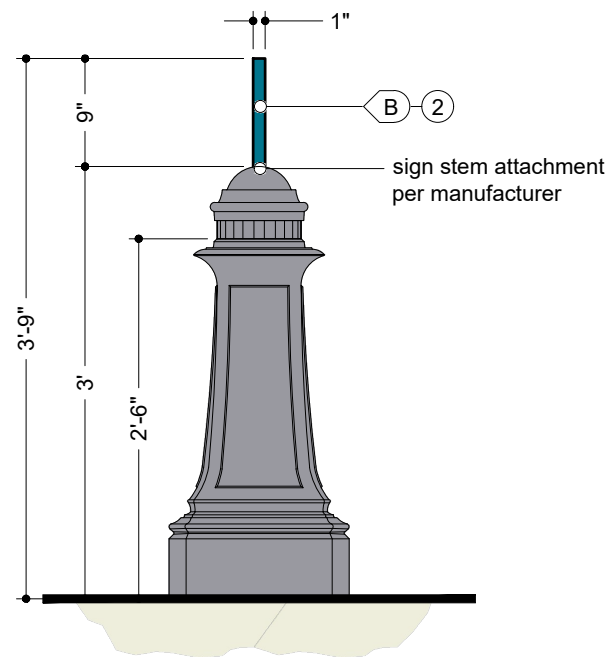

**2** Side Elevation  
Scale: 3/4" □ 1'-0"

KEY NOTES

**1. DECORATIVE BOLLARD**  
MATERIAL: structural grade aluminum  
MANUFACTURER: Sternberg 8401B bollard

**2. MILE MARKER SIGN**  
MATERIAL: aluminum  
SIZE: 9" dia. X 1" thick  
FABRICATION PROCESS: router cut  
EDGES: router cut, smooth finished smooth  
FASTENER: to manufacturers specifications  
GRAPHICS/TEXT: screen printed



GENERAL NOTES

- These drawings are intended to illustrate design intent only and are not for construction. All final engineering and conditions of the project are the responsibility of the fabricator. Shop drawings by the fabricator must be submitted for approval, prior to proceeding with fabrication.
- The quality of fit and finish on the final product must meet or exceed the requirements of these design intent documents. Any variations to design, materials, or fabrication methods must be approved by the Owner or Representative.
- Welds: All welds shall be ground smooth, paint all seams.
- Hardware: All exposed hardware shall be tamper proof fasteners.
- All exposed edges painted to match adjacent face.
- Colors shown are for reference only and are subject to the limitations of the printing process. Refer to referenced color systems contained within these drawings for actual specifications.
- Scaled examples shown are for reference only, and do not necessarily reflect actual site conditions. Detailed site surveys are required prior to fabrication and installation.
- Messages shown in these drawings are for general reference only. Refer to message schedules for actual required messages.

City of St. Helens

CLIENT

St. Helens Wayfinding

PROJECT

August 2017

DOCUMENT ISSUE

Off-Street Mile Marker

SHEET TITLE

8

SHEET NUMBER



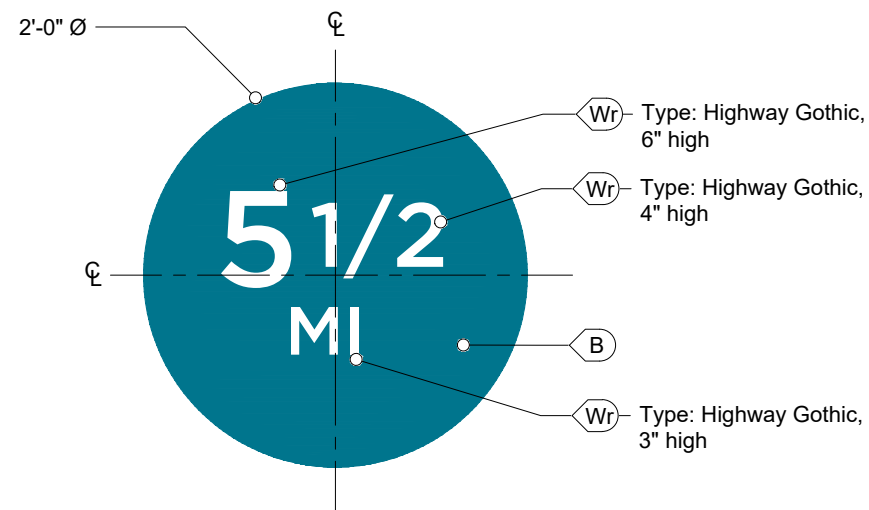

1 Detail  
Scale: 3/4" □ 1'-0"

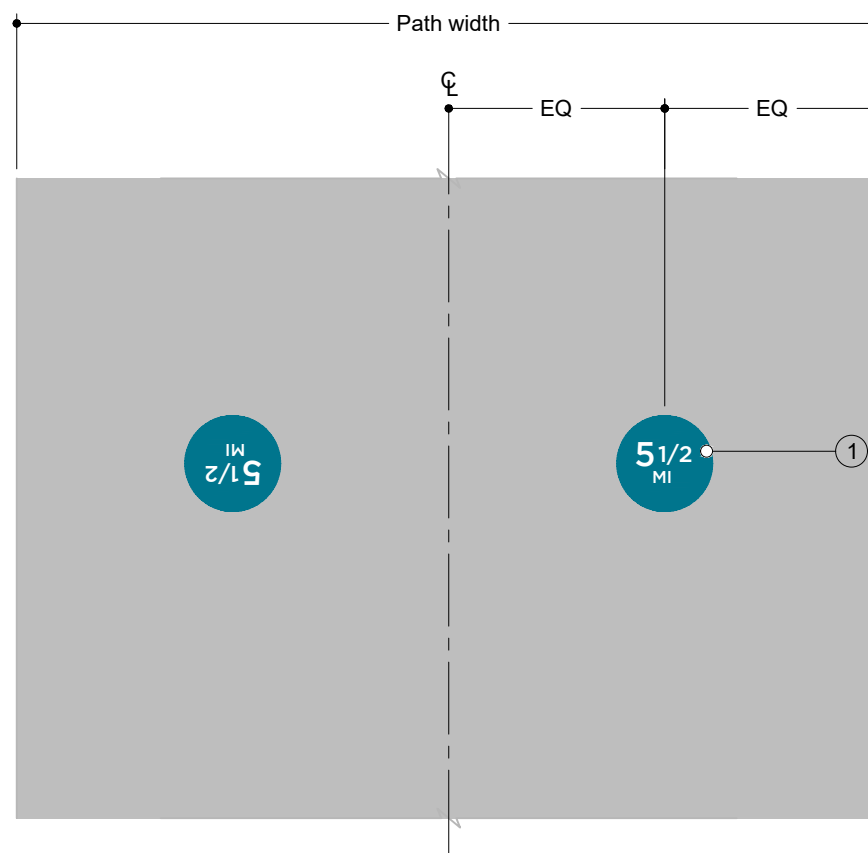

2 Typical Placement Plan  
Scale: 1/4" □ 1'-0"

KEY NOTES

**1. THERMOPLASTIC GRAPHIC PAVEMENT MARKER**  
 MATERIAL: thermoplastic  
 SIZE: 2'-0" dia



GENERAL NOTES

- These drawings are intended to illustrate design intent only and are not for construction. All final engineering and conditions of the project are the responsibility of the fabricator. Shop drawings by the fabricator must be submitted for approval, prior to proceeding with fabrication.
- The quality of fit and finish on the final product must meet or exceed the requirements of these design intent documents. Any variations to design, materials, or fabrication methods must be approved by the Owner or Representative.
- Welds: All welds shall be ground smooth, paint all seams.
- Hardware: All exposed hardware shall be tamper proof fasteners.
- All exposed edges painted to match adjacent face.
- Colors shown are for reference only and are subject to the limitations of the printing process. Refer to referenced color systems contained within these drawings for actual specifications.
- Scaled examples shown are for reference only, and do not necessarily reflect actual site conditions. Detailed site surveys are required prior to fabrication and installation.
- Messages shown in these drawings are for general reference only. Refer to message schedules for actual required messages.

City of St. Helens

CLIENT

St. Helens Wayfinding

PROJECT

August 2017

DOCUMENT ISSUE

Off-Street Pavement Marking

SHEET TITLE

9

SHEET NUMBER

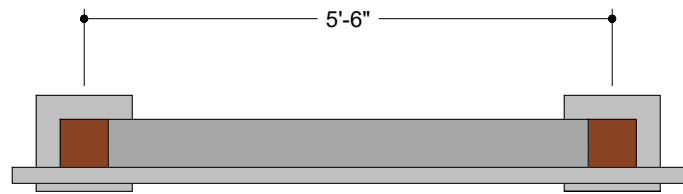

**4** Plan View  
Scale: 1/2" = 1'-0"

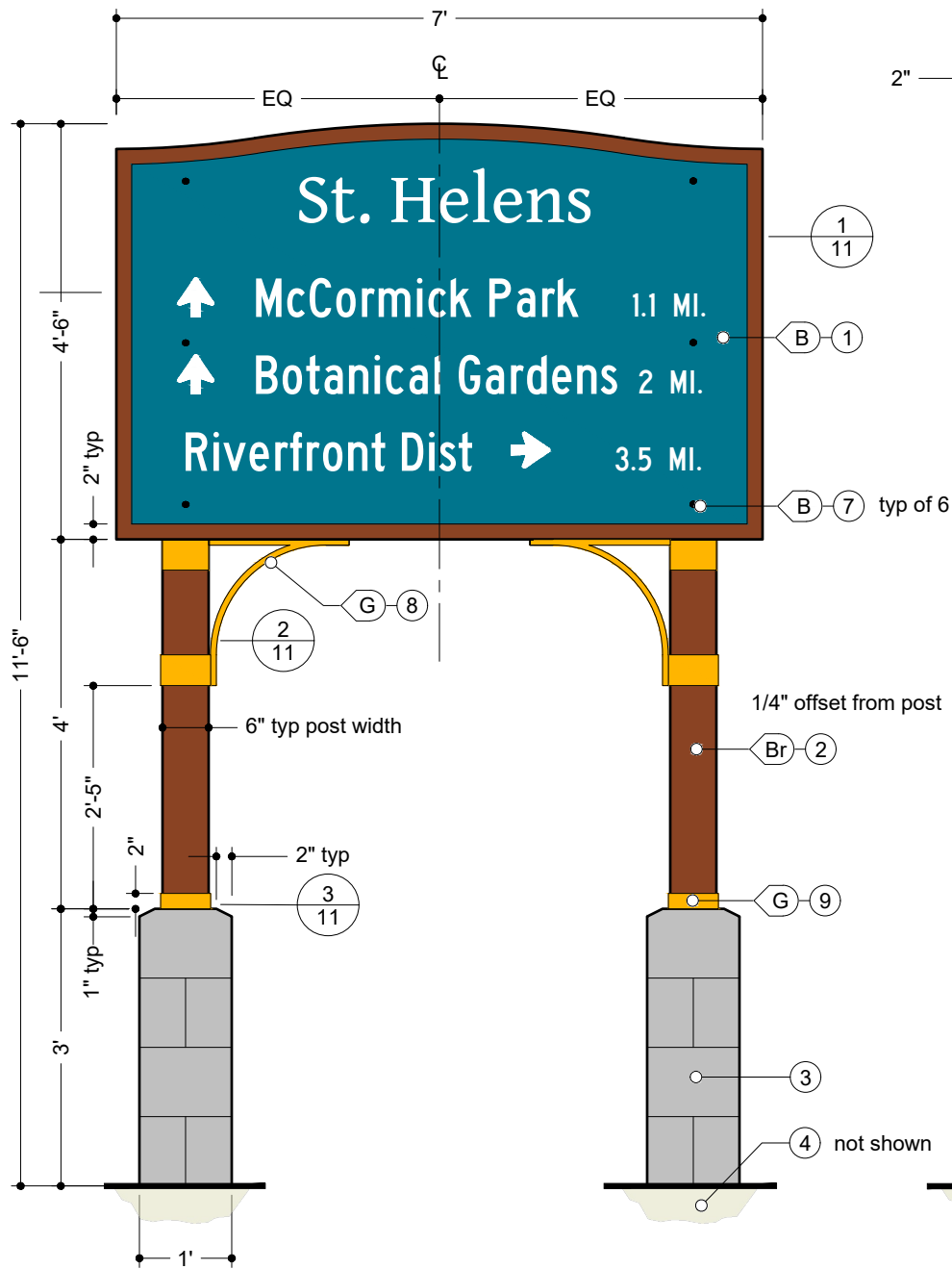

**1** Front Elevation  
Scale: 1/2" = 1'-0"

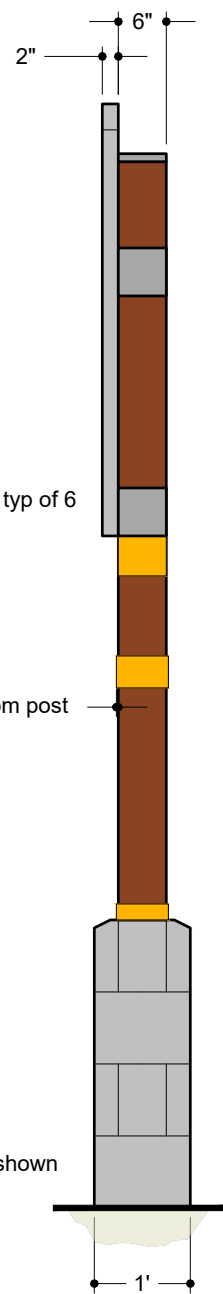

**2** Right Side Elevation  
Scale: 1/2" = 1'-0"

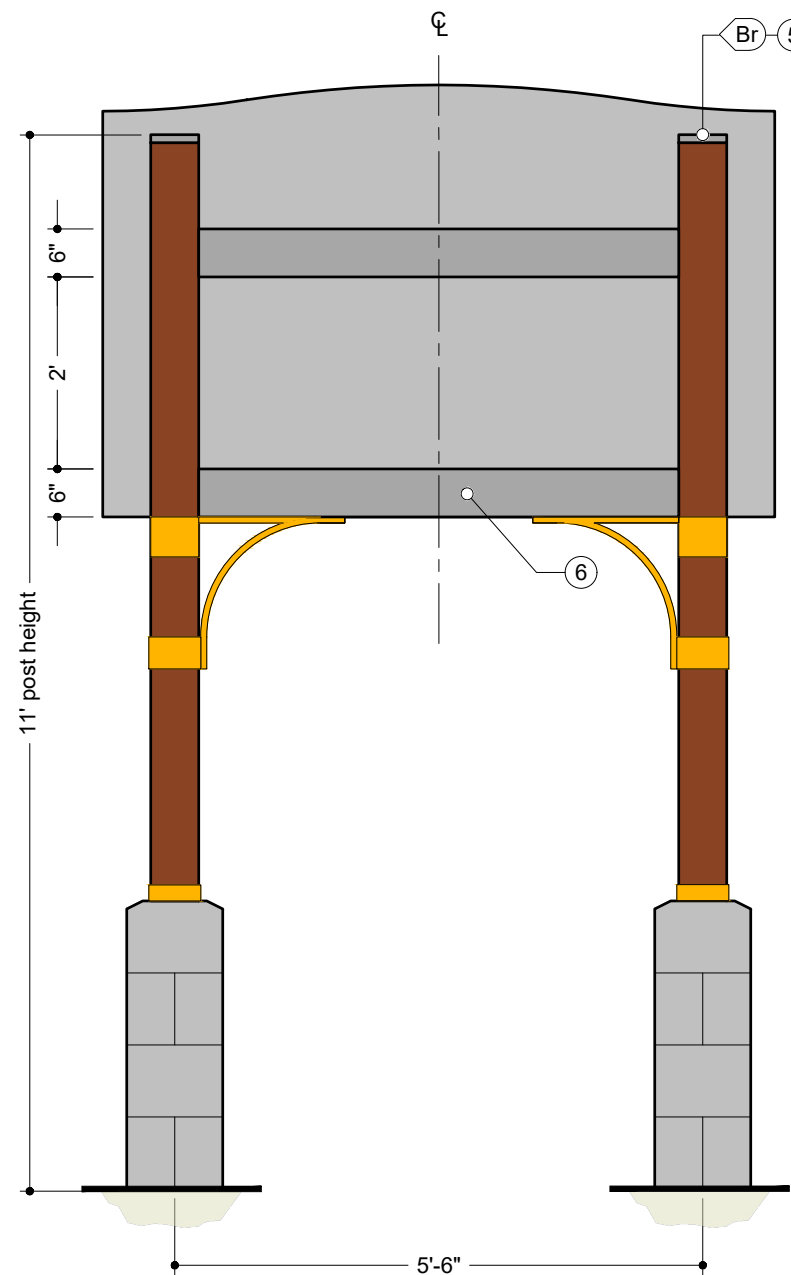

**3** Rear Elevation  
Scale: 1/2" = 1'-0"

KEY NOTES

- 1. SIGN PANEL**  
MATERIAL: 2" thick aluminum  
FABRICATION PROCESS: router cut  
EDGES: routed, finished smooth  
GRAPHICS/TEXT: screen printed  
COATING: UV protection  
FASTENER: mechanically fastened
- 2. POST**  
MATERIAL: 6" x 6" square steel tube,  
fabricator to engineer wall thickness,  
powder-coated aluminum
- 3. FOOTING**  
MATERIALS: Basalt style veneer  
SIZE: Per engineer's specifications
- 4. FOUNDATION**  
SIZE: Per engineer's specifications
- 5. POST CAP**  
MATERIAL: 1/4" steel plate  
FABRICATION PROCESS: welded
- 6. SUPPORT BEAM**  
MATERIAL: (2) 6" x 6" steel tube, welded to  
posts
- 7. BOLTS**  
(6) Tamper-proof thru-bolts, lock washers and  
nuts - fabricator to determine size  
MATERIAL: stainless steel - powder coated
- 8. DECORATIVE BRACKET**  
MATERIAL: Steel  
FABRICATION PROCESS: Welded
- 9. DECORATIVE BAND**  
MATERIAL: Steel  
FABRICATION PROCESS: Welded



GENERAL NOTES

- These drawings are intended to illustrate design intent only and are not for construction. All final engineering and conditions of the project are the responsibility of the fabricator. Shop drawings by the fabricator must be submitted for approval, prior to proceeding with fabrication.
- The quality of fit and finish on the final product must meet or exceed the requirements of these design intent documents. Any variations to design, materials, or fabrication methods must be approved by the Owner or Representative.
- Welds: All welds shall be ground smooth, paint all seams.
- Hardware: All exposed hardware shall be tamper proof fasteners.
- All exposed edges painted to match adjacent face.
- Colors shown are for reference only and are subject to the limitations of the printing process. Refer to referenced color systems contained within these drawings for actual specifications.
- Scaled examples shown are for reference only, and do not necessarily reflect actual site conditions. Detailed site surveys are required prior to fabrication and installation.
- Messages shown in these drawings are for general reference only. Refer to message schedules for actual required messages.

Vehicular directional signs not located within the Highway 30 right-of-way.

City of St. Helens

CLIENT

St. Helens Wayfinding

PROJECT

August 2017

DOCUMENT ISSUE

Typical Vehicular Directional Sign

SHEET TITLE

10

SHEET NUMBER

GENERAL NOTES

- These drawings are intended to illustrate design intent only and are not for construction. All final engineering and conditions of the project are the responsibility of the fabricator. Shop drawings by the fabricator must be submitted for approval, prior to proceeding with fabrication.
- The quality of fit and finish on the final product must meet or exceed the requirements of these design intent documents. Any variations to design, materials, or fabrication methods must be approved by the Owner or Representative.
- Welds: All welds shall be ground smooth, paint all seams.
- Hardware: All exposed hardware shall be tamper proof fasteners.
- All exposed edges painted to match adjacent face.
- Colors shown are for reference only and are subject to the limitations of the printing process. Refer to referenced color systems contained within these drawings for actual specifications.
- Scaled examples shown are for reference only, and do not necessarily reflect actual site conditions. Detailed site surveys are required prior to fabrication and installation.
- Messages shown in these drawings are for general reference only. Refer to message schedules for actual required messages.

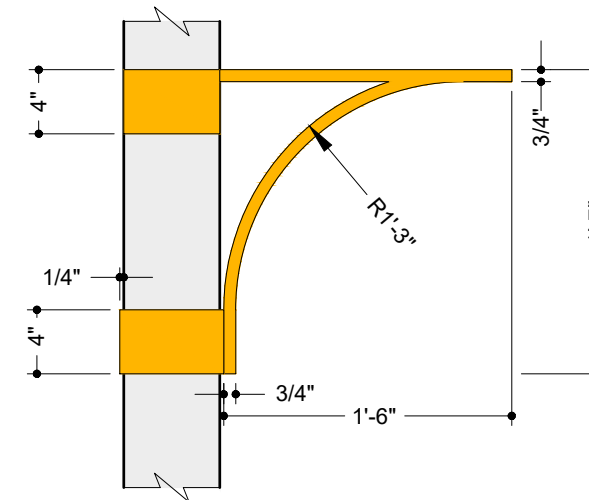

2 Bracket Detail  
 Scale: 1" □ 1'-0"

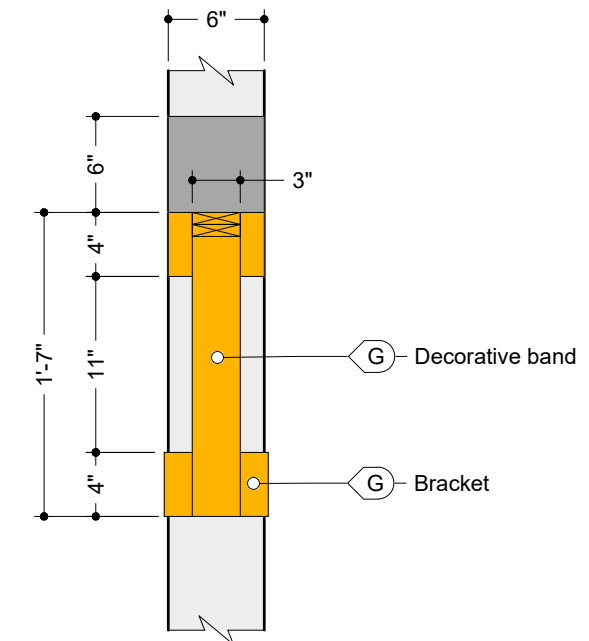

3 Bracket and Band Elevation  
 Scale: 1" □ 1'-0"

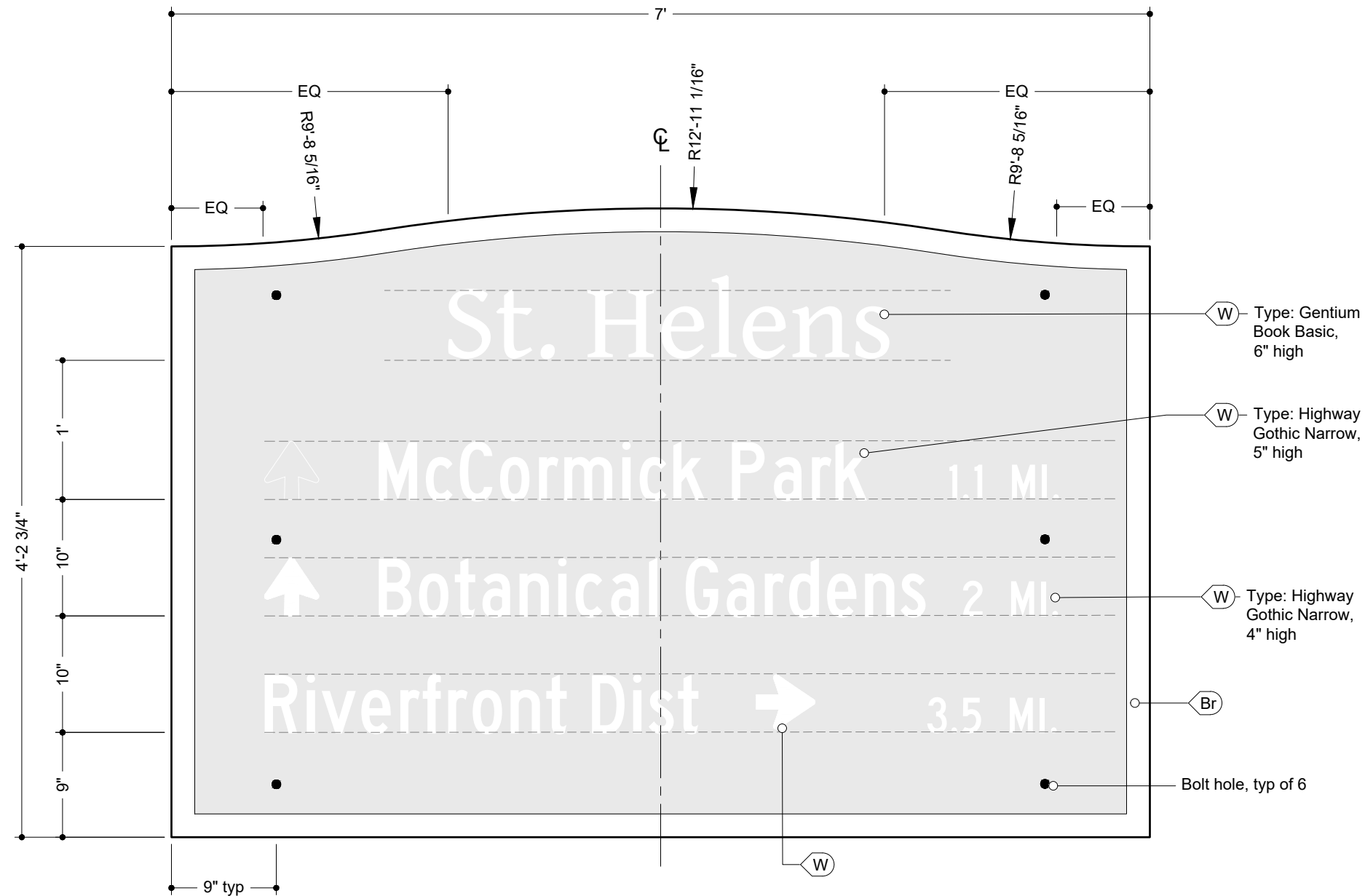

1 Typical Sign Detail  
 Scale: 1" □ 1'-0"

City of St. Helens

CLIENT

St. Helens Wayfinding

PROJECT

August 2017

DOCUMENT ISSUE

Typical Vehicular Directional Sign Detail

SHEET TITLE

11

SHEET NUMBER

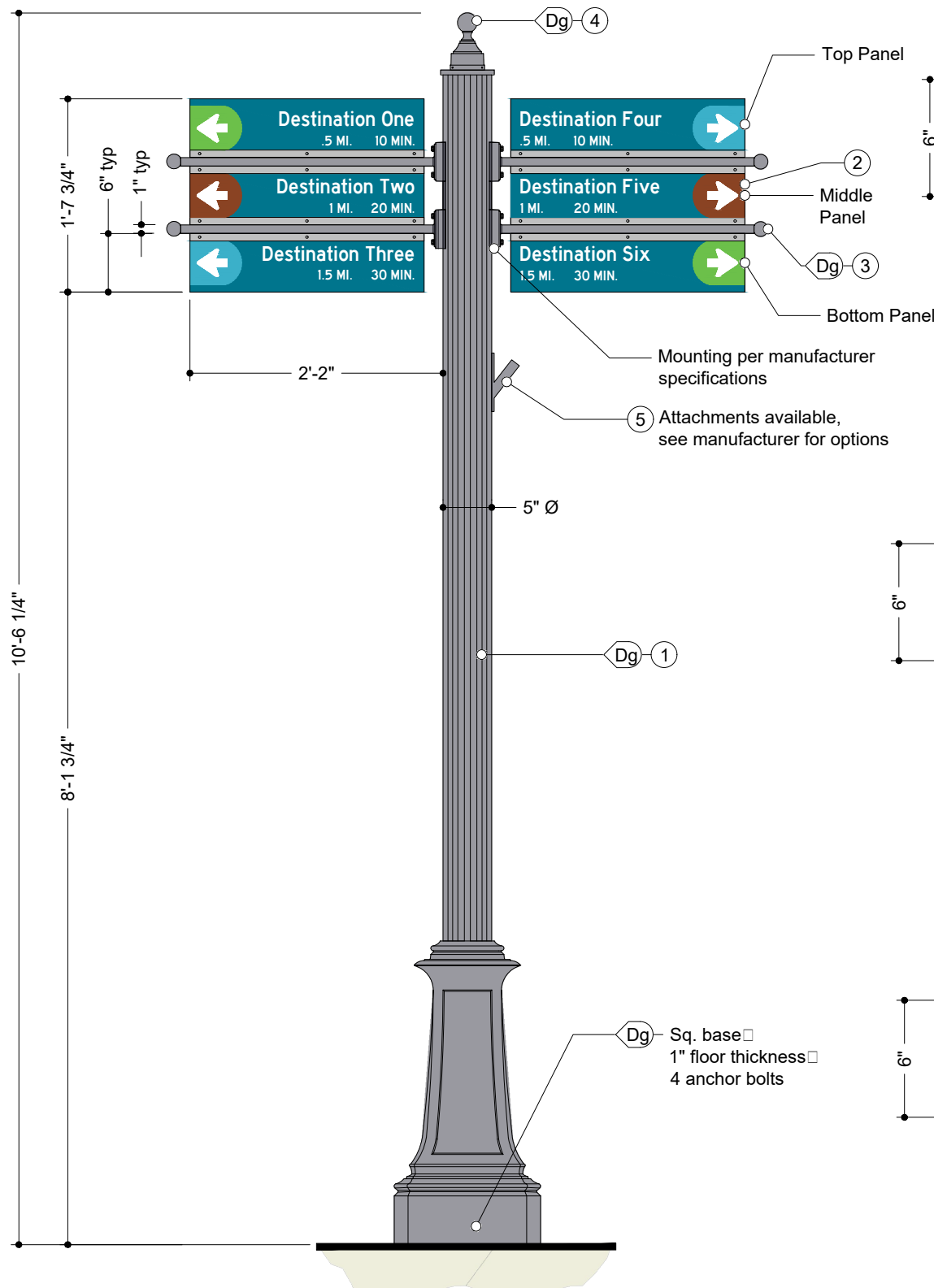

**1** Front Elevation  
Scale: 3/4" □ 1'-0"

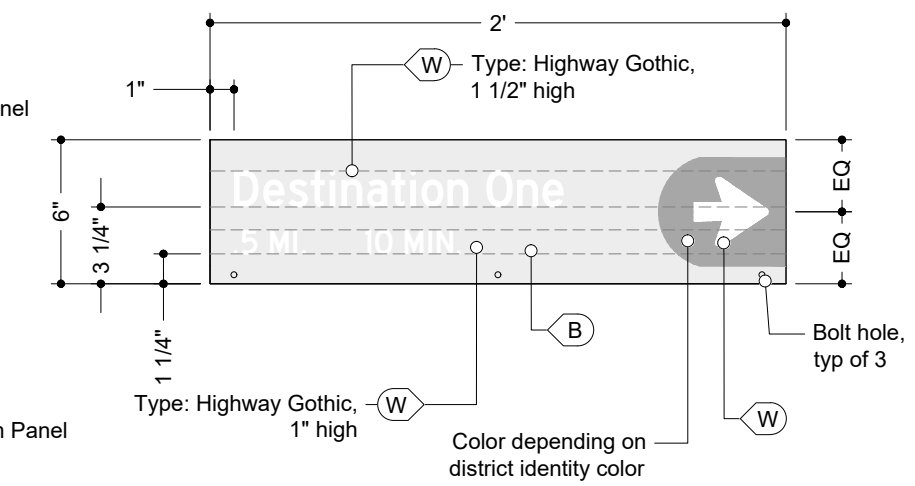

**Top Panel**

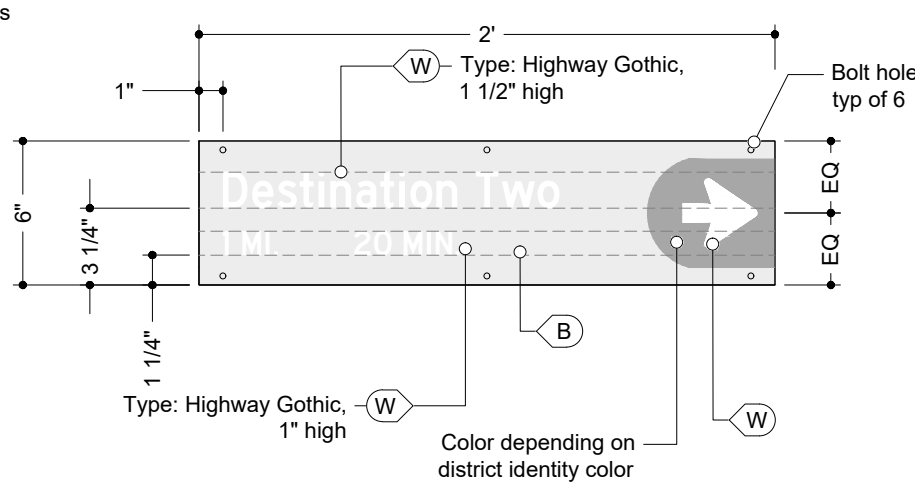

**Middle Panel**

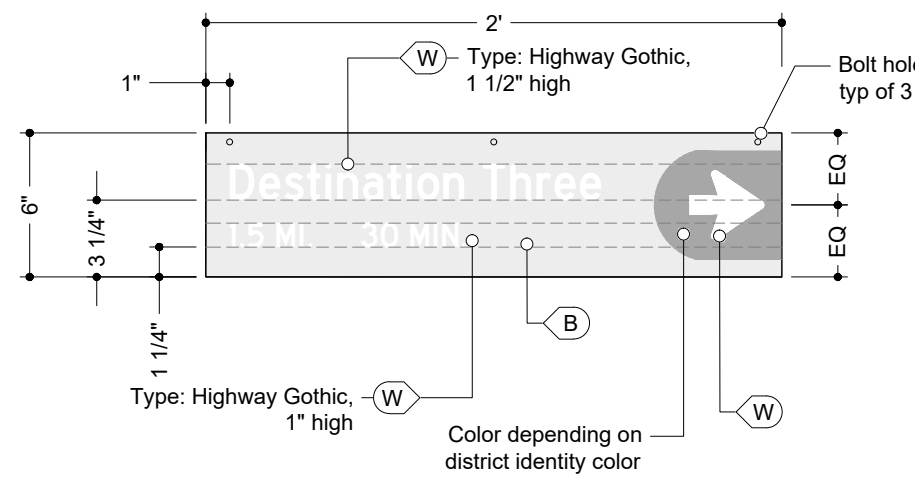

**Bottom Panel**

**2** Typical Sign Detail  
Scale: 1 1/2" □ 1'-0"

KEY NOTES

- 1. DECORATIVE POLE**  
MATERIAL: 5" diameter aluminum □ 188 wall thickness 6061-Tg structural grade □ fluted  
MANUFACTURER: Sternberg Lighting □ built for single unit construction □ 15" sq. base, 1" floor thickness, 4 anchor bolts
- 2. SIGN BLADE**  
MATERIAL: 1/8" thick aluminum  
SIZE: 24" x 6", double sided  
MANUFACTURER: Sternberg Lighting □ model 2-SABA
- 3. BANNER ARM**  
MATERIAL: aluminum  
MANUFACTURER: Sternberg Lighting, Sternberg banner arm with 4 24" long channels □ 1/4" wide 1/8" deep
- 4. CAP**  
MATERIAL: aluminum  
MANUFACTURER: Sternberg Lighting □ BCC - Ball Center Cap
- 5. OPTIONAL POST ATTACHMENTS**  
MATERIAL: aluminum FH Flag Pole Holder □ WHK Wreath Hook Mount  
MANUFACTURER: Sternberg Lighting



GENERAL NOTES

- These drawings are intended to illustrate design intent only and are not for construction. All final engineering and conditions of the project are the responsibility of the fabricator. Shop drawings by the fabricator must be submitted for approval, prior to proceeding with fabrication.
- The quality of fit and finish on the final product must meet or exceed the requirements of these design intent documents. Any variations to design, materials, or fabrication methods must be approved by the Owner or Representative.
- Welds: All welds shall be ground smooth, paint all seams.
- Hardware: All exposed hardware shall be tamper proof fasteners.
- All exposed edges painted to match adjacent face.
- Colors shown are for reference only and are subject to the limitations of the printing process. Refer to referenced color systems contained within these drawings for actual specifications.
- Scaled examples shown are for reference only, and do not necessarily reflect actual site conditions. Detailed site surveys are required prior to fabrication and installation.
- Messages shown in these drawings are for general reference only. Refer to message schedules for actual required messages.

City of St. Helens  
CLIENT

St. Helens Wayfinding  
PROJECT

August 2017  
DOCUMENT ISSUE

On-Street Directional Sign  
SHEET TITLE

12  
SHEET NUMBER

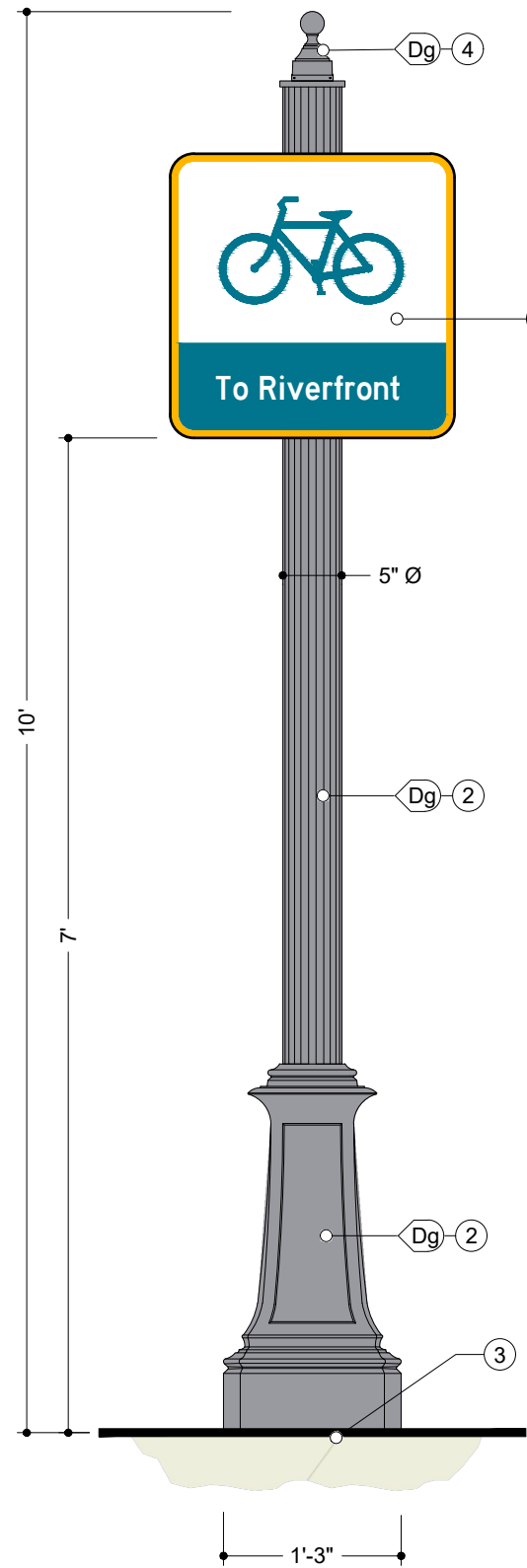

Confirmation Sign

1 Front Elevation  
Scale: 3/4" □ 1'-0"

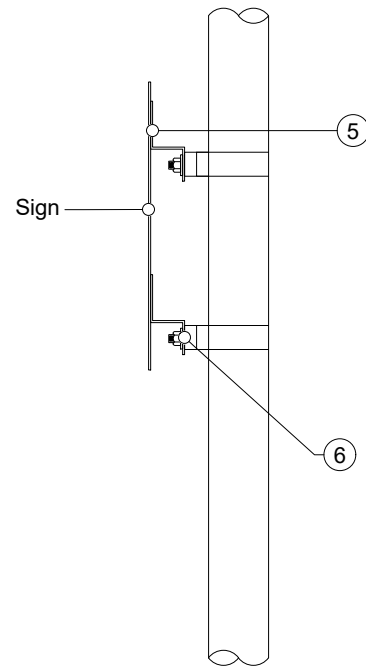

Side

2 Sign Mounting Detail  
Scale: 3/4" □ 1'-0"

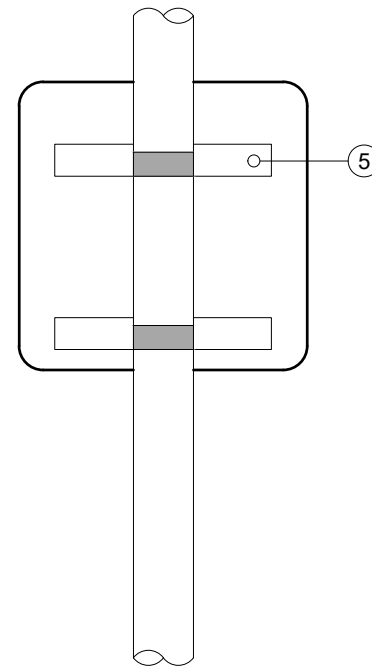

Back

KEY NOTES

1. **SIGN PANEL**  
 MATERIAL: 1/8" thick aluminum  
 FABRICATION PROCESS: router cut  
 EDGES: routed, finished smooth  
 GRAPHICS/TEXT: screen printed  
 COATING: UV protection  
 FASTENER: (2) 5/16" x 2-1/2" SST bolts w/ SST washers
2. **DECORATIVE POLE**  
 MATERIAL: 5" diameter aluminum □ 188 wall thickness 6061-Tg structural grade □ fluted  
 MANUFACTURER: Sternberg Lighting □ built for single unit construction □ 15" sq. base, 1" floor thickness, 4 anchor bolts
3. **FOUNDATION**  
 SIZE: to engineer's specifications
4. **CAP**  
 MATERIAL: aluminum  
 MANUFACTURER: Sternberg Lighting □ built for single unit construction
5. **Z-ANGLE BRACKET**  
 MATERIAL: aluminum z-angle bracket  
 FASTENER: fill weld to back of sign panel
6. **BOLTS**  
 Tamper-proof through-bolts, lock washers and nuts □ fabricator to determine size  
 MATERIAL: stainless steel



GENERAL NOTES

- These drawings are intended to illustrate design intent only and are not for construction. All final engineering and conditions of the project are the responsibility of the fabricator. Shop drawings by the fabricator must be submitted for approval, prior to proceeding with fabrication.
- The quality of fit and finish on the final product must meet or exceed the requirements of these design intent documents. Any variations to design, materials, or fabrication methods must be approved by the Owner or Representative.
- Welds: All welds shall be ground smooth, paint all seams.
- Hardware: All exposed hardware shall be tamper proof fasteners.
- All exposed edges painted to match adjacent face.
- Colors shown are for reference only and are subject to the limitations of the printing process. Refer to referenced color systems contained within these drawings for actual specifications.
- Scaled examples shown are for reference only, and do not necessarily reflect actual site conditions. Detailed site surveys are required prior to fabrication and installation.
- Messages shown in these drawings are for general reference only. Refer to message schedules for actual required messages.

City of St. Helens

CLIENT

St. Helens Wayfinding

PROJECT

August 2017

DOCUMENT ISSUE

On-Street Sign

SHEET TITLE

13

SHEET NUMBER

GENERAL NOTES

- These drawings are intended to illustrate design intent only and are not for construction. All final engineering and conditions of the project are the responsibility of the fabricator. Shop drawings by the fabricator must be submitted for approval, prior to proceeding with fabrication.
- The quality of fit and finish on the final product must meet or exceed the requirements of these design intent documents. Any variations to design, materials, or fabrication methods must be approved by the Owner or Representative.
- Welds: All welds shall be ground smooth, paint all seams.
- Hardware: All exposed hardware shall be tamper proof fasteners.
- All exposed edges painted to match adjacent face.
- Colors shown are for reference only and are subject to the limitations of the printing process. Refer to referenced color systems contained within these drawings for actual specifications.
- Scaled examples shown are for reference only, and do not necessarily reflect actual site conditions. Detailed site surveys are required prior to fabrication and installation.
- Messages shown in these drawings are for general reference only. Refer to message schedules for actual required messages.

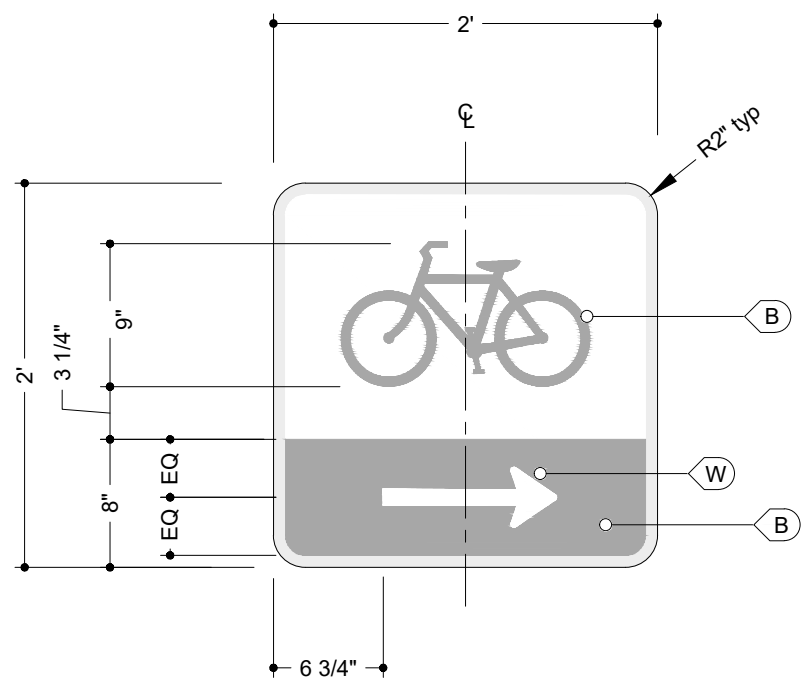

Typical Turn

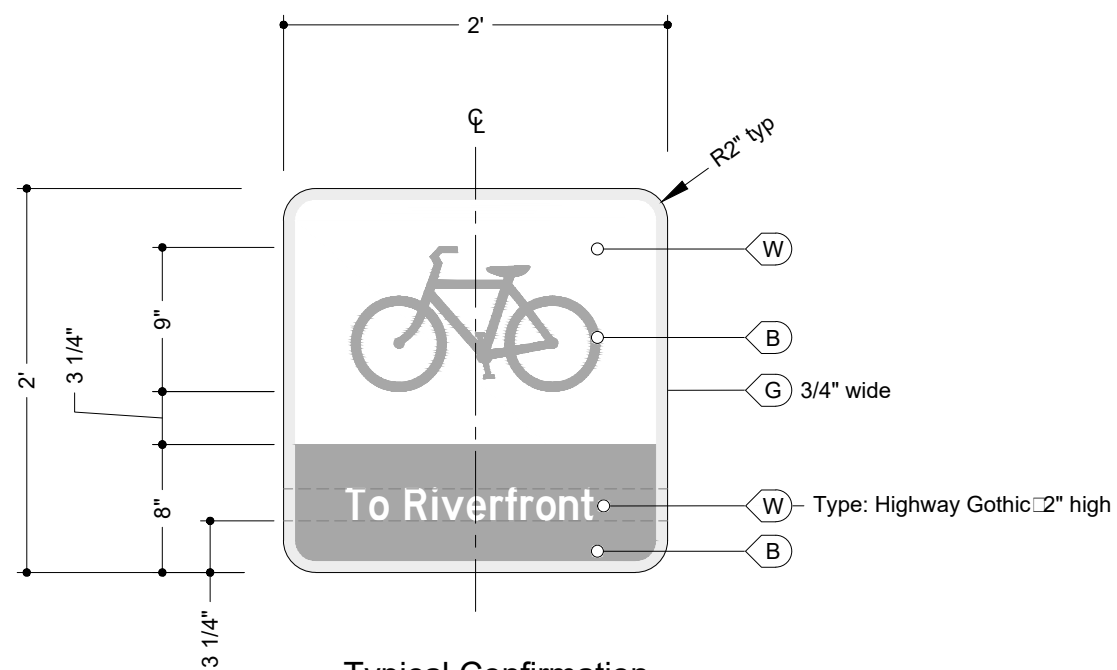

Typical Confirmation

1 Sign Detail  
 Scale: 1" □ 1'-0"

City of St. Helens

CLIENT

St. Helens Wayfinding

PROJECT

August 2017

DOCUMENT ISSUE

Confirmation & Turn Layout

SHEET TITLE

14

SHEET NUMBER

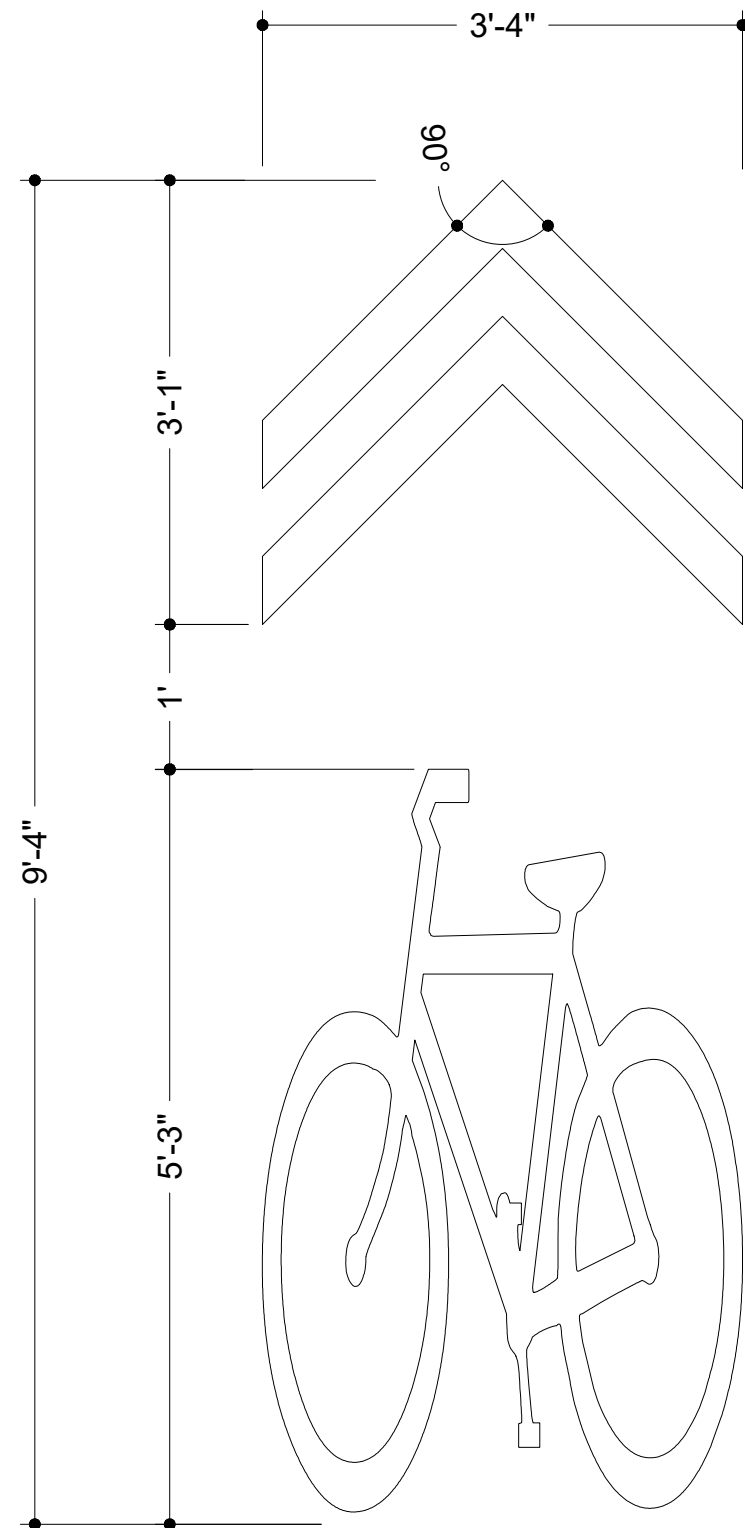

**1** Detail  
Scale: 3/4" □ 1'-0"

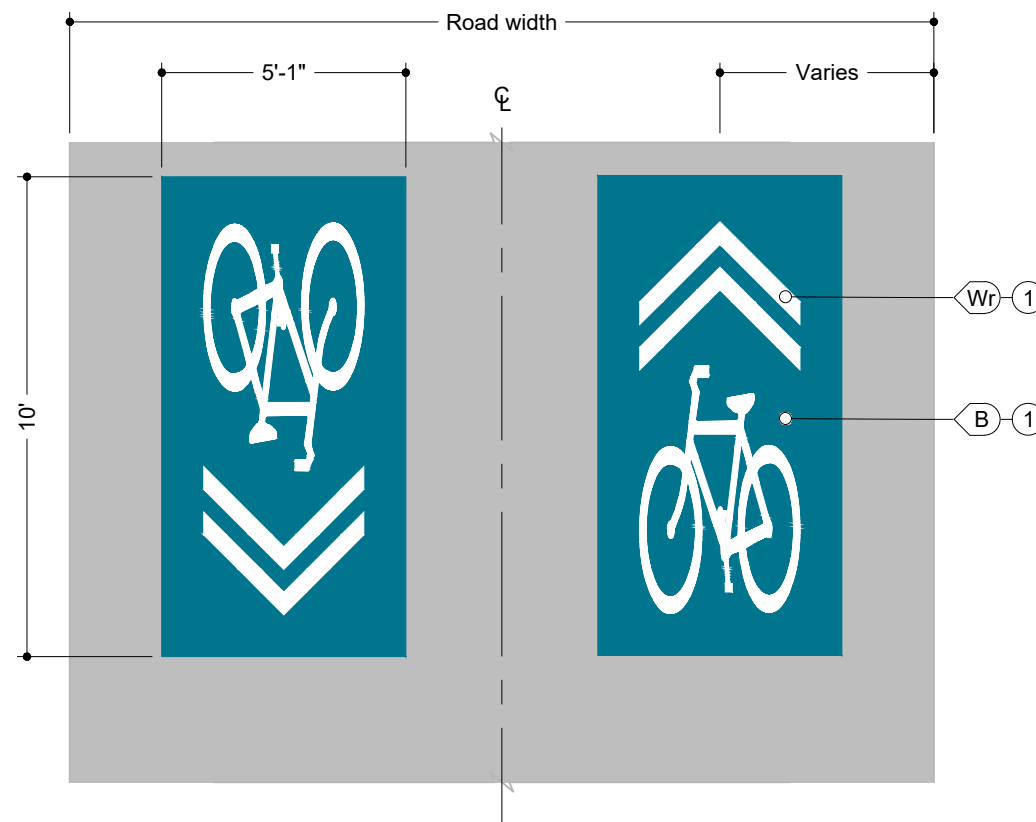

**2** Typical Placement Plan  
Scale: 1/4" □ 1'-0"

KEY NOTES

**1. THERMOPLASTIC GRAPHIC PAVEMENT MARKER**  
**MATERIAL:** thermoplastic  
**SIZE:** 3'-4"W x 9'-4" L



GENERAL NOTES

- These drawings are intended to illustrate design intent only and are not for construction. All final engineering and conditions of the project are the responsibility of the fabricator. Shop drawings by the fabricator must be submitted for approval, prior to proceeding with fabrication.
- The quality of fit and finish on the final product must meet or exceed the requirements of these design intent documents. Any variations to design, materials, or fabrication methods must be approved by the Owner or Representative.
- Welds: All welds shall be ground smooth, paint all seams.
- Hardware: All exposed hardware shall be tamper proof fasteners.
- All exposed edges painted to match adjacent face.
- Colors shown are for reference only and are subject to the limitations of the printing process. Refer to referenced color systems contained within these drawings for actual specifications.
- Scaled examples shown are for reference only, and do not necessarily reflect actual site conditions. Detailed site surveys are required prior to fabrication and installation.
- Messages shown in these drawings are for general reference only. Refer to message schedules for actual required messages.

City of St. Helens

CLIENT

St. Helens Wayfinding

PROJECT

August 2017

DOCUMENT ISSUE

On-Street Pavement Marking

SHEET TITLE

15

SHEET NUMBER

GENERAL NOTES

- These drawings are intended to illustrate design intent only and are not for construction. All final engineering and conditions of the project are the responsibility of the fabricator. Shop drawings by the fabricator must be submitted for approval, prior to proceeding with fabrication.
- The quality of fit and finish on the final product must meet or exceed the requirements of these design intent documents. Any variations to design, materials, or fabrication methods must be approved by the Owner or Representative.
- Welds: All welds shall be ground smooth, paint all seams.
- Hardware: All exposed hardware shall be tamper proof fasteners.
- All exposed edges painted to match adjacent face.
- Colors shown are for reference only and are subject to the limitations of the printing process. Refer to referenced color systems contained within these drawings for actual specifications.
- Scaled examples shown are for reference only, and do not necessarily reflect actual site conditions. Detailed site surveys are required prior to fabrication and installation.
- Messages shown in these drawings are for general reference only. Refer to message schedules for actual required messages.

City of St. Helens

CLIENT

St. Helens Wayfinding

PROJECT

August 2017

DOCUMENT ISSUE

Gateway Sign

SHEET TITLE

16

SHEET NUMBER

KEY NOTES

1. SIGN FRAME

MATERIAL: 1/8" thick aluminum  
 FRAME: Fabricated aluminum channel internal structure to engineer's specification. Frame to be set inside perimeter of sign sleeve.

2. PUSH THROUGH LETTERS

MATERIAL: UV resistant and non-yellowing acrylic. 2" proud of sign face. Edge and face illumination  
 FABRICATION PROCESS: Sign to be internally lit  
 EDGES: Fully welded and fabricated sides with all edges and corners neatly finished

3. DECORATION ATTACHMENTS

Stainless steel eye bolts attached to bottom of sign frame. Count and spacing per contractor specifications

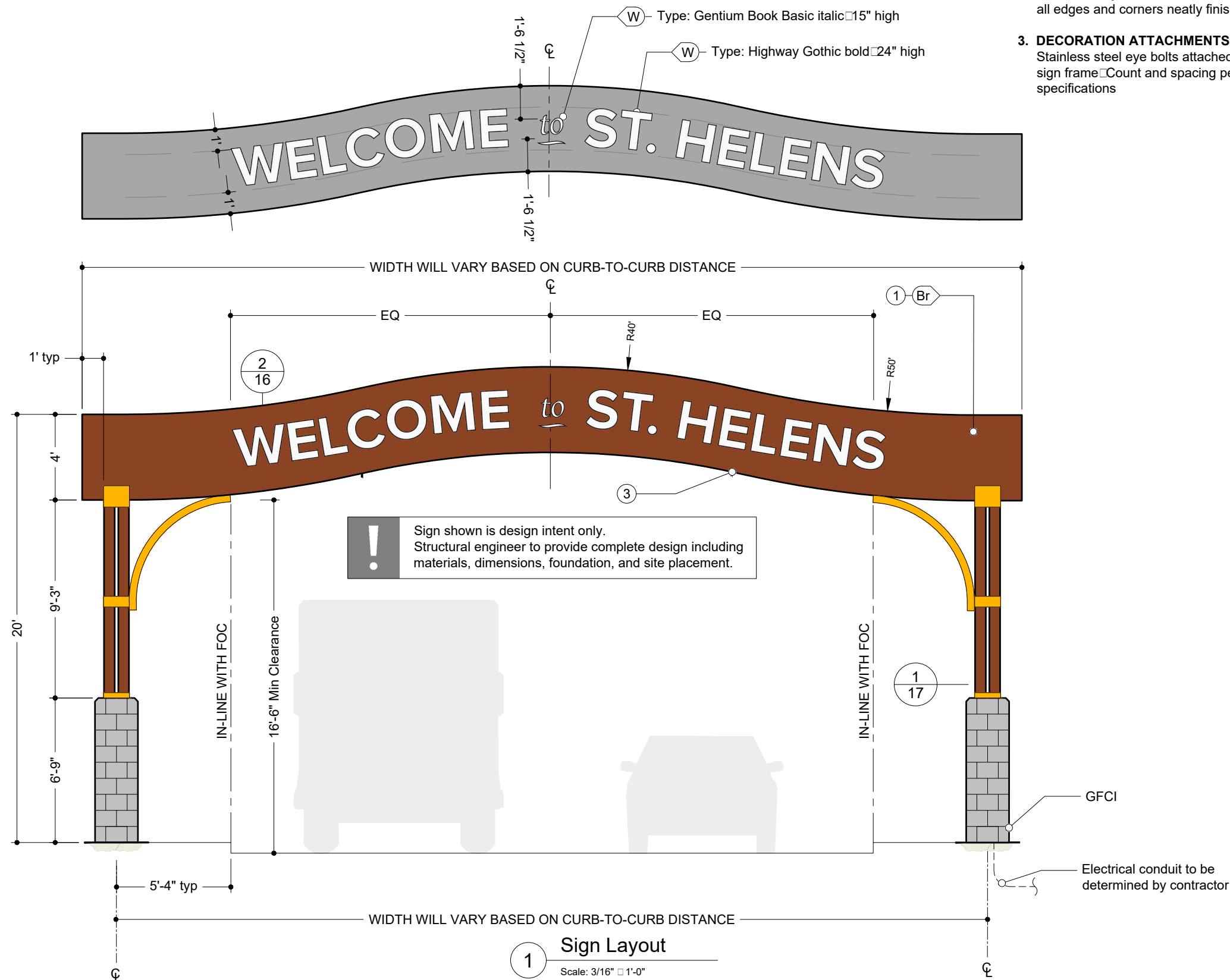

1 Sign Layout  
 Scale: 3/16" = 1'-0"



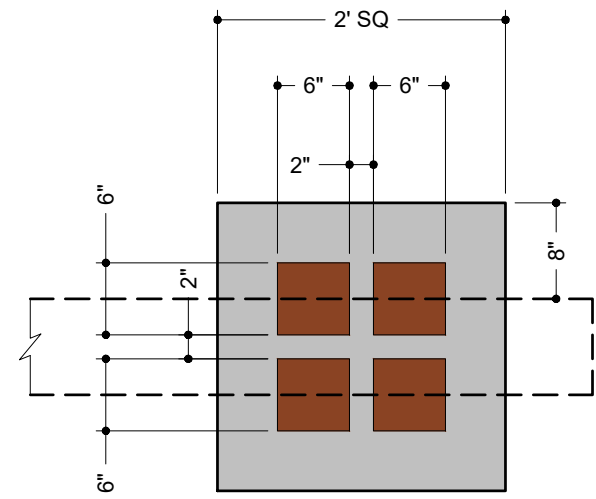

Plan

3 Post Detail  
Scale: 1/4" □ 1'-0"

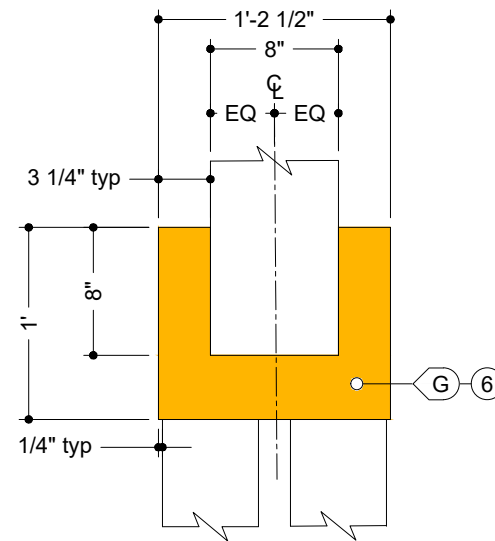

4 Top Bracket Detail  
Scale: 1" □ 1'-0"

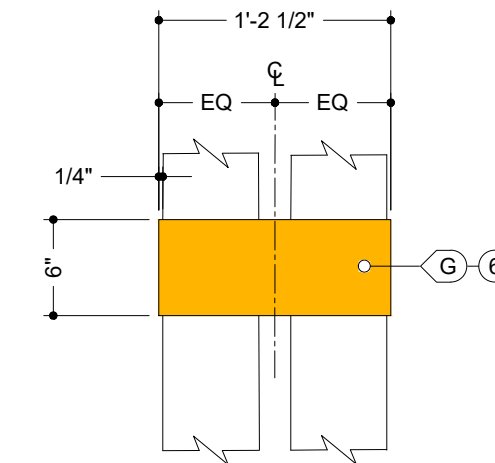

5 Middle Bracket Detail  
Scale: 1" □ 1'-0"

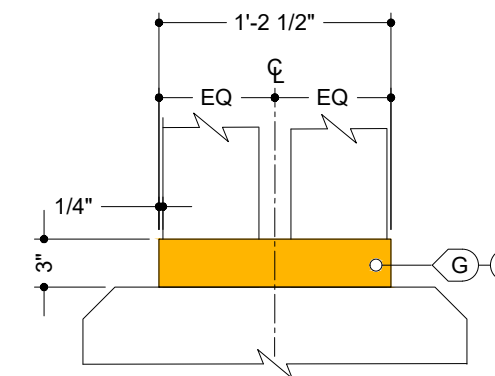

6 Bottom Bracket Detail  
Scale: 1" □ 1'-0"

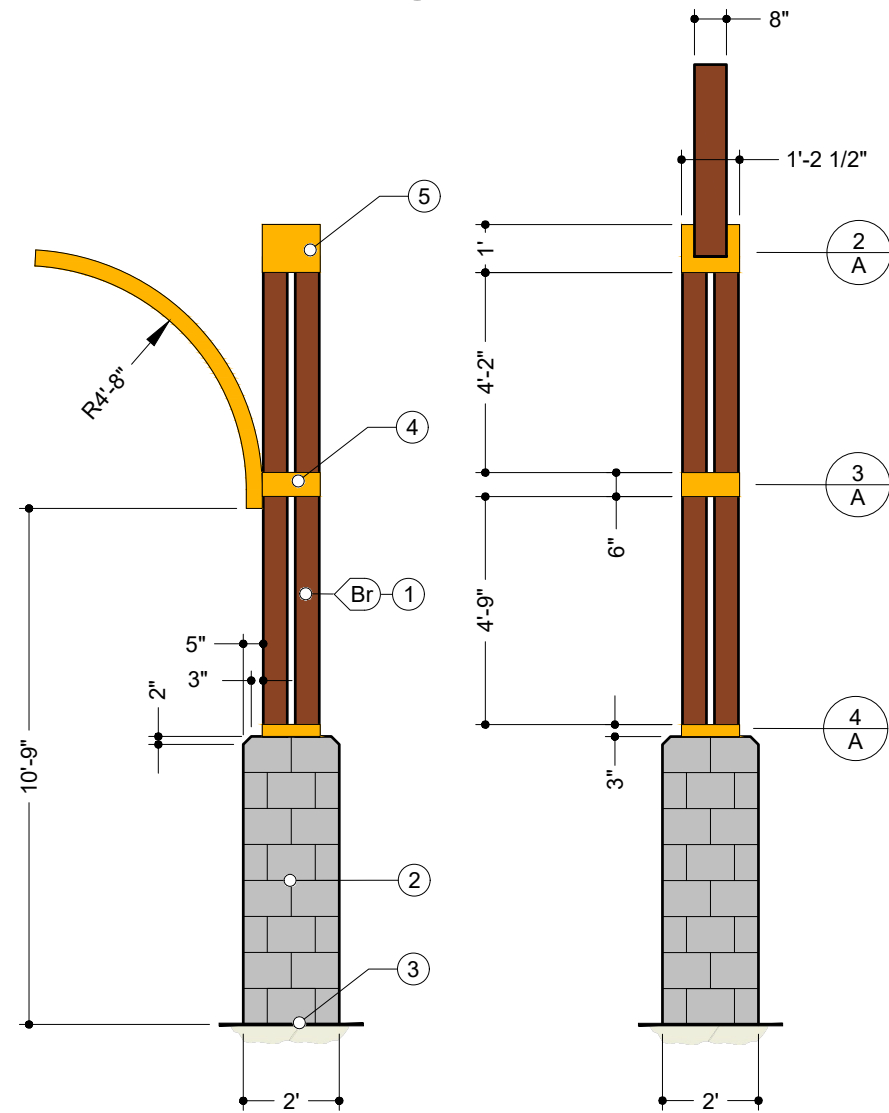

1 Front Elevation  
Scale: 1/4" □ 1'-0"

2 Right Side Elevation  
Scale: 1/4" □ 1'-0"

- KEY NOTES**
- POST**  
MATERIAL: (4) 6" x 6" square steel post, fabricator to engineer wall thickness; powder-coated aluminum
  - BASE**  
MATERIAL: Basalt veneer over CMU / precast concrete
  - FOOTING**  
MANUFACTURER: Per engineer's specifications
  - DECORATIVE BRACKET**  
MATERIAL: Steel  
FABRICATION PROCESS: Welded
  - DECORATIVE BAND**  
MATERIAL: Steel  
FABRICATION PROCESS: Welded



- GENERAL NOTES**
- These drawings are intended to illustrate design intent only and are not for construction. All final engineering and conditions of the project are the responsibility of the fabricator. Shop drawings by the fabricator must be submitted for approval, prior to proceeding with fabrication.
  - The quality of fit and finish on the final product must meet or exceed the requirements of these design intent documents. Any variations to design, materials, or fabrication methods must be approved by the Owner or Representative.
  - Welds: All welds shall be ground smooth, paint all seams.
  - Hardware: All exposed hardware shall be tamper proof fasteners.
  - All exposed edges painted to match adjacent face.
  - Colors shown are for reference only and are subject to the limitations of the printing process. Refer to referenced color systems contained within these drawings for actual specifications.
  - Scaled examples shown are for reference only, and do not necessarily reflect actual site conditions. Detailed site surveys are required prior to fabrication and installation.
  - Messages shown in these drawings are for general reference only. Refer to message schedules for actual required messages.

City of St. Helens

CLIENT

St. Helens Wayfinding

PROJECT

August 2017

DOCUMENT ISSUE

Gateway Sign Details

SHEET TITLE

17

SHEET NUMBER

**!** Sign shown is design intent only. Structural engineer to provide complete design including materials, dimensions, foundation, and site placement.

GENERAL NOTES

- These drawings are intended to illustrate design intent only and are not for construction. All final engineering and conditions of the project are the responsibility of the fabricator. Shop drawings by the fabricator must be submitted for approval, prior to proceeding with fabrication.
- The quality of fit and finish on the final product must meet or exceed the requirements of these design intent documents. Any variations to design, materials, or fabrication methods must be approved by the Owner or Representative.
- Welds: All welds shall be ground smooth, paint all seams.
- Hardware: All exposed hardware shall be tamper proof fasteners.
- All exposed edges painted to match adjacent face.
- Colors shown are for reference only and are subject to the limitations of the printing process. Refer to referenced color systems contained within these drawings for actual specifications.
- Scaled examples shown are for reference only, and do not necessarily reflect actual site conditions. Detailed site surveys are required prior to fabrication and installation.
- Messages shown in these drawings are for general reference only. Refer to message schedules for actual required messages.

- SIGN PANEL**  
MATERIAL: 2" thick aluminum  
FABRICATION PROCESS: router cut  
EDGES: routed, finished smooth  
GRAPHICS/TEXT: screen printed  
COATING: UV protection  
FASTENER: mechanically fastened
- POST**  
MATERIAL: (2) 6" x 6" square steel tube, fabricator to engineer wall thickness, powder-coated aluminum
- FOOTING**  
MANUFACTURER: ODOT square tube sign support with triangle base breakaway □ DET4241
- POST CAP**  
MATERIAL: 1/4" steel plate  
FABRICATION PROCESS: welded
- SUPPORT BEAM**  
MATERIAL: (2) 6" x 6" steel tube, welded to posts
- BOLTS**  
(6) Tamper-proof thru-bolts, lock washers and nuts □ fabricator to determine size  
MATERIAL: stainless steel
- DECORATIVE BRACKET**  
MATERIAL: Steel  
FABRICATION PROCESS: Welded
- DECORATIVE BAND**  
MATERIAL: Steel  
FABRICATION PROCESS: Welded

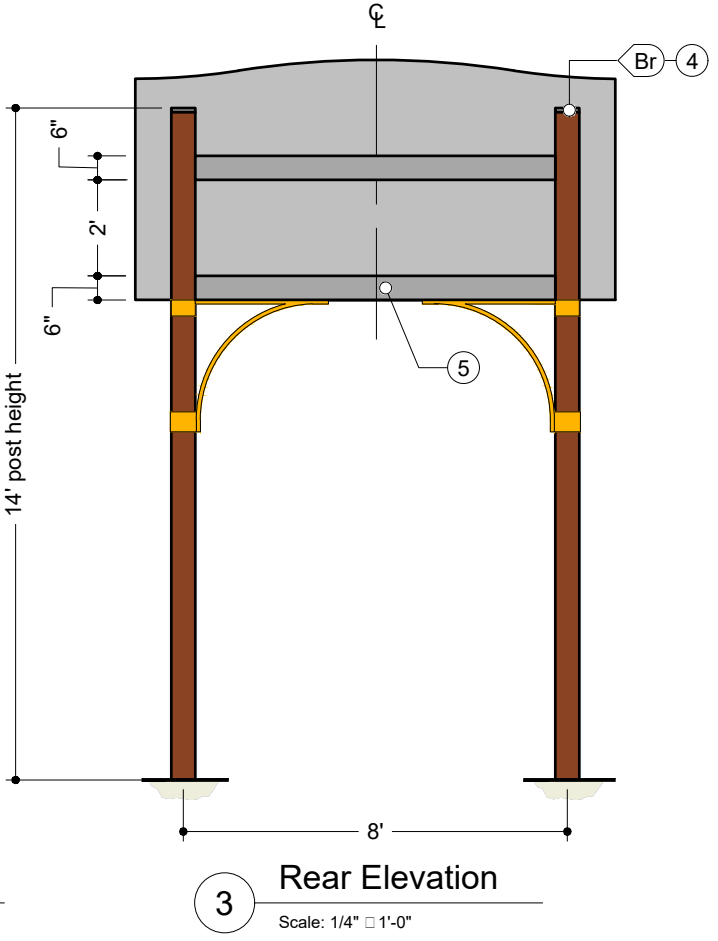
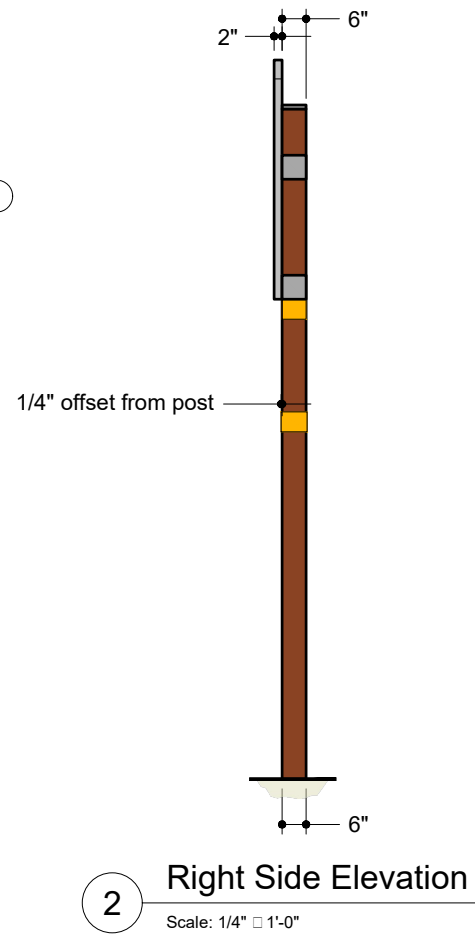
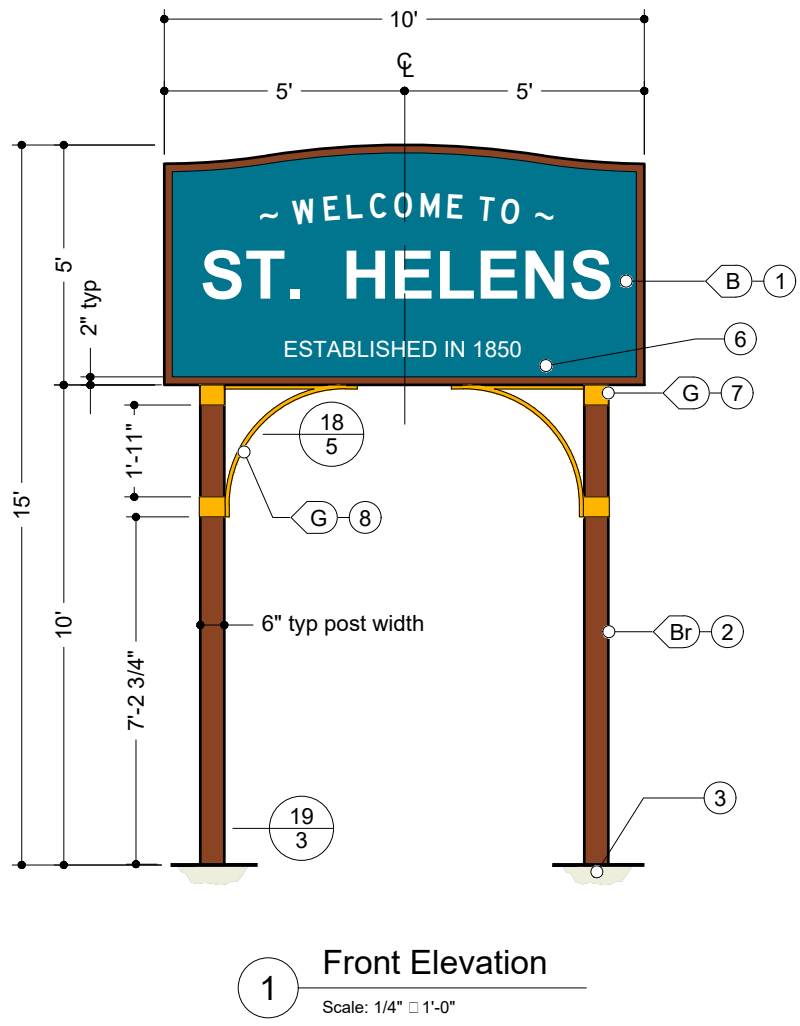
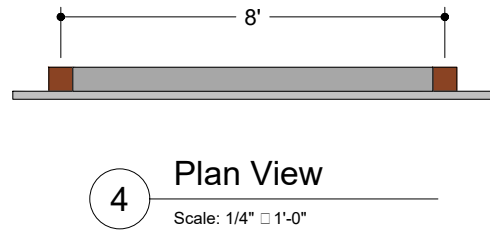
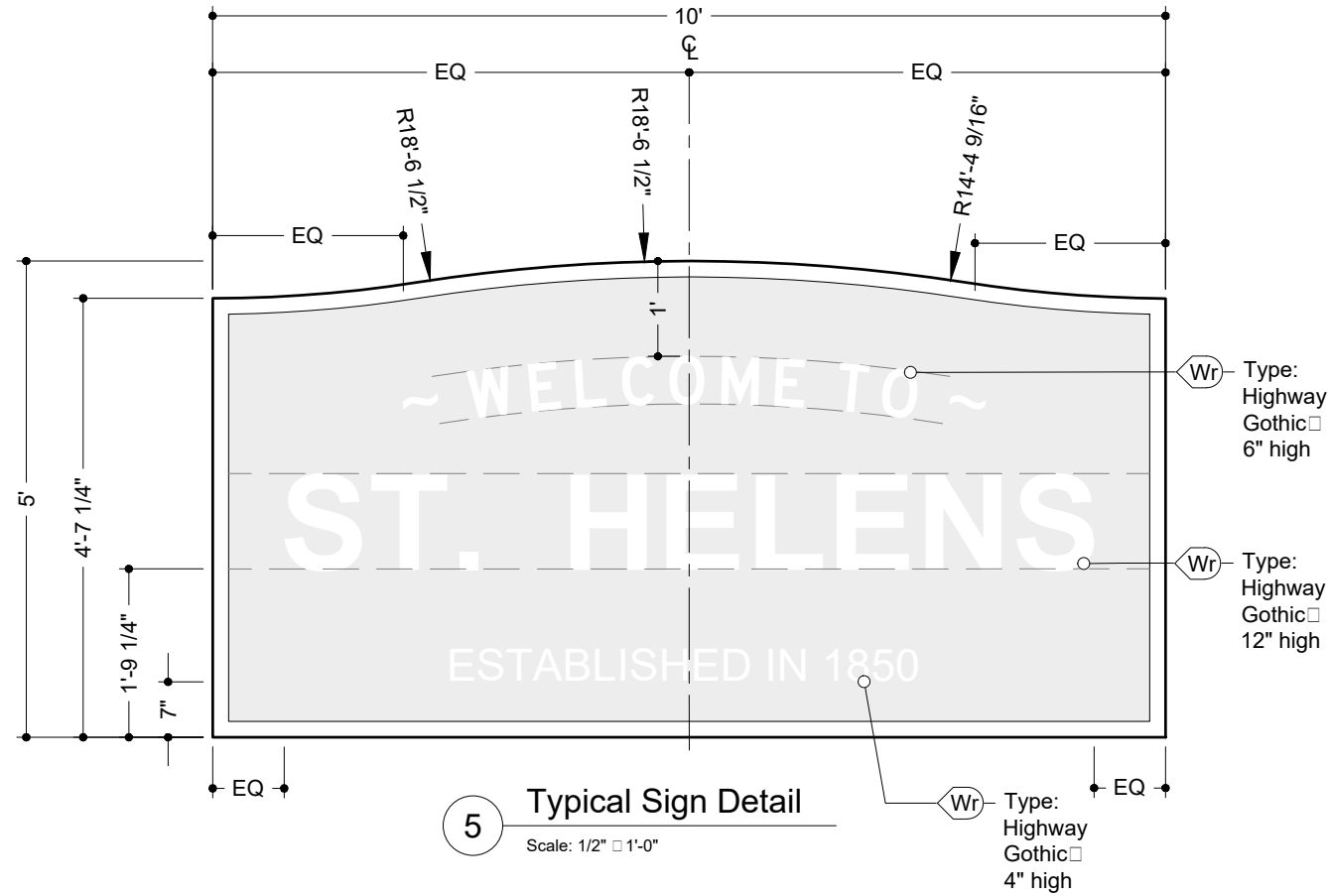

City of St. Helens

CLIENT

St. Helens Wayfinding

PROJECT

August 2017

DOCUMENT ISSUE

Highway Identity Sign

SHEET TITLE

18

SHEET NUMBER

GENERAL NOTES

- These drawings are intended to illustrate design intent only and are not for construction. All final engineering and conditions of the project are the responsibility of the fabricator. Shop drawings by the fabricator must be submitted for approval, prior to proceeding with fabrication.
- The quality of fit and finish on the final product must meet or exceed the requirements of these design intent documents. Any variations to design, materials, or fabrication methods must be approved by the Owner or Representative.
- Welds: All welds shall be ground smooth, paint all seams.
- Hardware: All exposed hardware shall be tamper proof fasteners.
- All exposed edges painted to match adjacent face.
- Colors shown are for reference only and are subject to the limitations of the printing process. Refer to referenced color systems contained within these drawings for actual specifications.
- Scaled examples shown are for reference only, and do not necessarily reflect actual site conditions. Detailed site surveys are required prior to fabrication and installation.
- Messages shown in these drawings are for general reference only. Refer to message schedules for actual required messages.

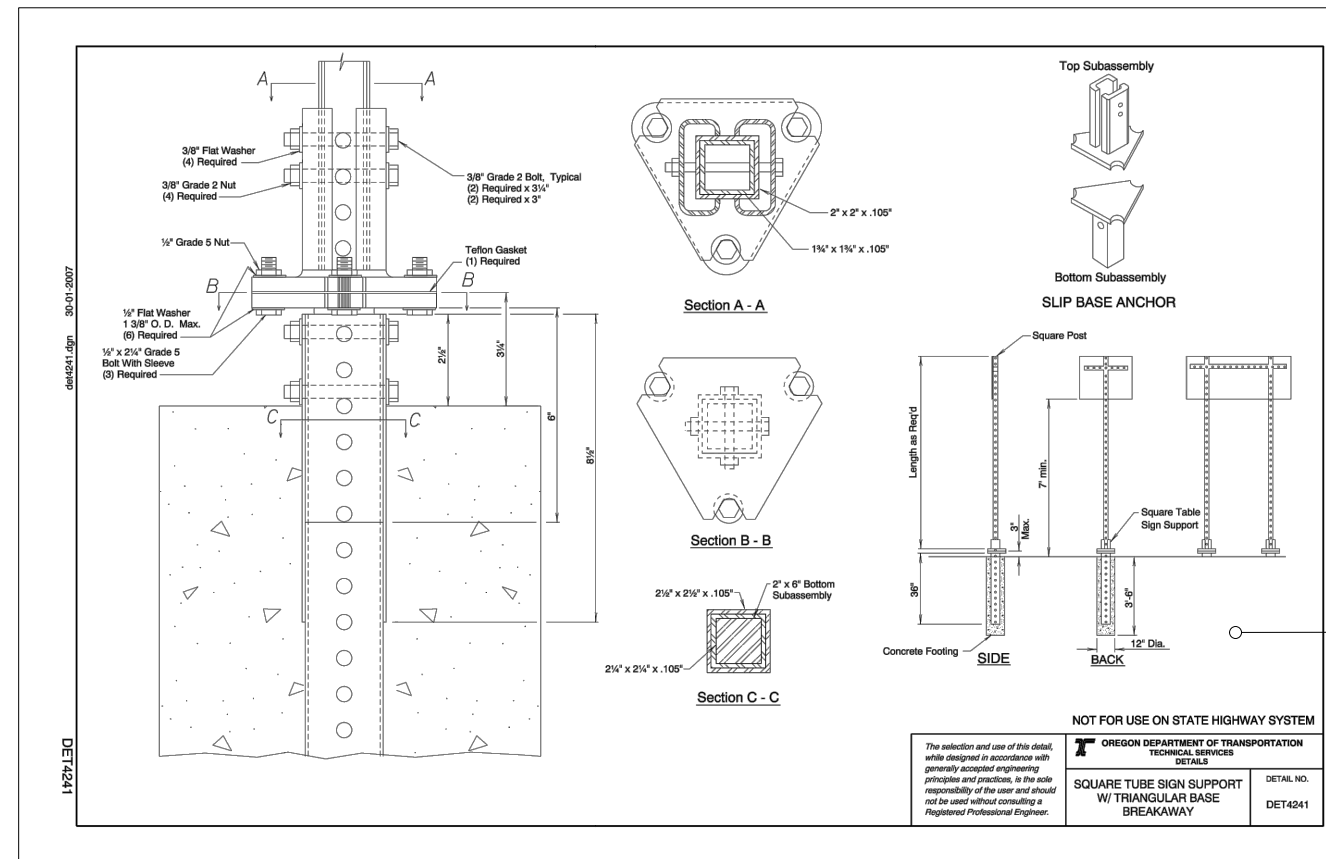

ODOT base detail  
 Sign base to be sized appropriately for post size

**3** ODOT Triangle Breakaway Base Detail  
 No Scale

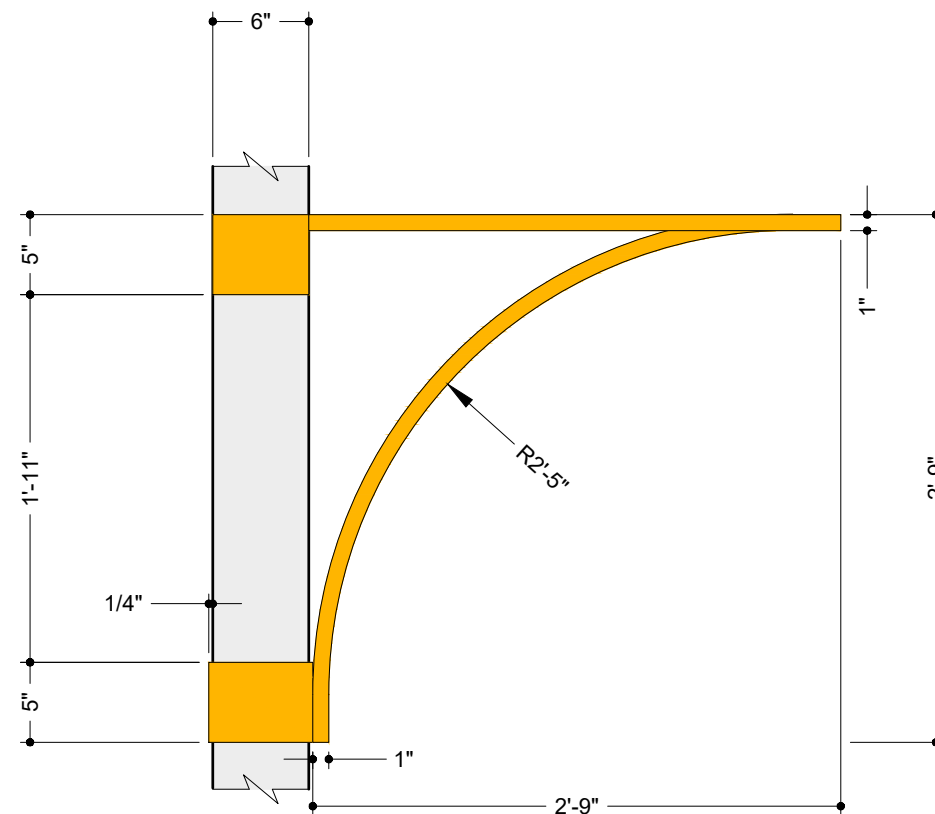

**1** Bracket Detail  
 Scale: 1" □ 1'-0"

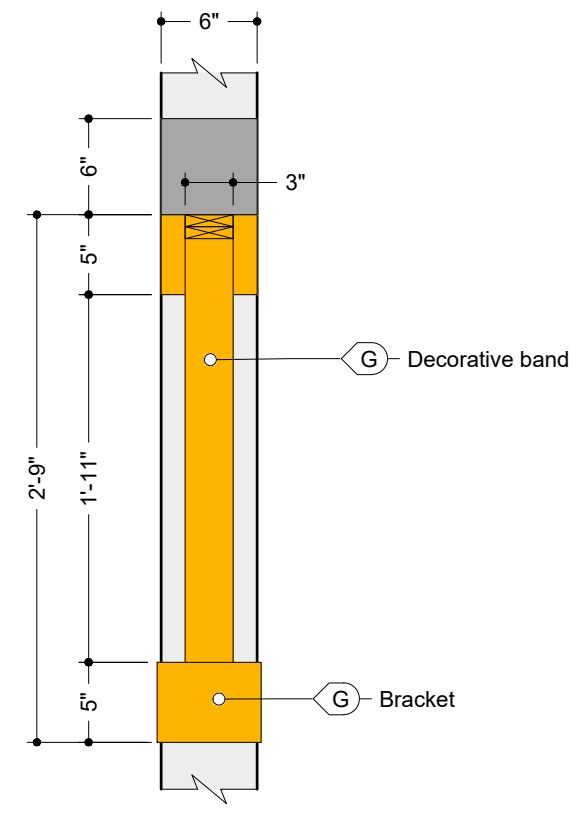

**2** Bracket and Band Elevation  
 Scale: 1" □ 1'-0"

City of St. Helens  
 CLIENT

St. Helens Wayfinding  
 PROJECT

August 2017  
 DOCUMENT ISSUE

Highway Identity Sign Details  
 SHEET TITLE

19  
 SHEET NUMBER

# SIGN PLACEMENT

# PLANS

## St. Helens Wayfinding

October 2017  
Resolution No. 1800



City of St. Helens  
265 Strand Street  
St. Helens, Oregon, 97051

Contact: Jennifer Dimsho, Associate Planner  
Ph: 503.366.8207

### TABLE OF CONTENTS

Sign Schedule	SP 1	Sign Placement: Signs 25-28	SP 8
Overview Map	SP 1	Hwy 30 Sign Inventory	SP 9
Sign Reference	SP 1	Hwy 30 Sign Relocation Part 1	SP 10
Sign Placement: Signs 1-4	SP 2	Hwy 30 Sign Relocation Part 2	SP 11
Sign Placement: Signs 5-8	SP 3		
Sign Placement: Signs 9-12	SP 4		
Sign Placement: Signs 13-16	SP 5		
Sign Placement: Signs 17-20	SP 6		
Sign Placement: Signs 21-24	SP 7		



### Alta Planning + Design

711 SE Grand Ave  
Portland, Oregon, 97214  
Ph: 503.230.9862

# SIGN SCHEDULE

ID	Sign Type	Arrows	Destinations	Distance/Ti me		Installation Location Detail (Sheet #)
1	Highway Identity	N/A	N/A	N/A	N/A	2
2	Highway Identity	N/A	N/A	N/A	N/A	2
3	Gateway	N/A	N/A	N/A	N/A	2
4	Kiosk	N/A	N/A	N/A	N/A	2
5	On-Street Directional	↑	Riverfront Dist	1.0 mi	6 min	3
		↑	Grey Cliffs Park	1.2 mi	7 min	
		→	McCormick Park	0.3 mi	2 min	
6	On-Street Confirmation	N/A	McCormick Park	N/A	N/A	3
7	On-Street Directional	↑	Historic Dist	0.8 mi	5 min	3
		↑	Columbia View Park	1.0 mi	6 min	
		←	Transit Center	0.9 mi	6 min	
		←	Middle School	0.4 mi	3 min	
8	On-Street Confirmation	N/A	Houlton Bus Dist	N/A	N/A	3
		↑	Historic Dist	0.6 mi	3 min	
9	Vehicular Directional	↑	Riverfront Dist	0.7 mi	4 min	4
		↑	Courthouse Plaza	0.9 mi	6 min	
		↑	Transit Center	0.3 mi	2 min	
10	On-Street Directional	→	Transit Center	0.3 mi	2 min	4
		→	Middle School	0.8 mi	5 min	
11	On-Street Confirmation	N/A	Houlton Bus Dist	N/A	N/A	4
12	On-Street Directional	←	McCormick Park	0.4 mi	3 min	4
		←	Library	0.4 mi	3 min	
		←	Veteran's Memorial	0.6 mi	3 min	
13	On-Street Confirmation	N/A	Houlton Bus Dist	N/A	N/A	5
14	On-Street Confirmation	N/A	Riverfront Dist	N/A	N/A	5
		↑	Riverfront Dist	0.4 mi	3 min	
15	Vehicular Directional	↑	Historic Dist	0.3 mi	2 min	5
		↑	Courthouse Plaza	0.6 mi	3 min	
		↑	Houlton Business Dist	0.4 mi	3 min	
16	On-Street Directional	↑	McCormick Park	1.0 mi	6 min	5
		→	6th Street Park	0.7 mi	4 min	
17	On-Street Directional	↑	Riverfront Dist	0.2 mi	1 min	6
		←	Godfrey Park	0.1 mi	1 min	
		→	Nob Hill Park	0.6 mi	3 min	
18	On-Street Directional	↑	Houlton Business Dist	0.5 mi	3 min	6
		↑	McCormick Park	1.0 mi	6 min	
		←	Nob Hill Park	0.5 mi	3 min	
19	On-Street Turn	←	N/A	N/A	N/A	6
20	On-Street Directional	↑	Riverfront Dist	0.1 mi	1 min	6
		↑	Columbia View Park	.25 mi	1 min	
		↑	Grey Cliffs Park	0.5 mi	3 min	
21	On-Street Directional	←	Riverfront Dist	.05 mi	1 min	7
		←	Historic Dist	.05 mi	1 min	
		←	Columbia View Park	0.3 mi	2 min	
22	On-Street Directional	←	Nob Hill Park	0.2 mi	1 min	7
		→	Godfrey Park	0.4 mi	3 min	
23	On-Street Turn	→	N/A	N/A	N/A	7
24	On-Street Directional Sign	←	Grey Cliffs Park	0.3 mi	3 min	7
		←	Boat Launch	0.2 mi	1 min	
		→	Courthouse Plaza	0.1 mi	1 min	
		↗	City Hall	0.1 mi	1 min	
		↗	Columbia View Park	0.1 mi	1 min	
25	Kiosk	N/A	N/A	N/A	N/A	8
26	Kiosk	N/A	N/A	N/A	N/A	8
27	Vehicular Directional	→	Historic Dist	0.1 mi	1 min	8
		→	Riverfront Dist	0.1 mi	1 min	
		→	Columbia View Park	.25 mi	1 min	
28	On-Street Directional Sign	←	Grey Cliffs Park	0.1 mi	1 min	8
		←	Boat Launch	.05 mi	1 min	
		→	Courthouse Plaza	.25 mi	1 min	
		→	Columbia View Park	0.3 mi	1 min	

## OVERVIEW MAP



## SIGN REFERENCE

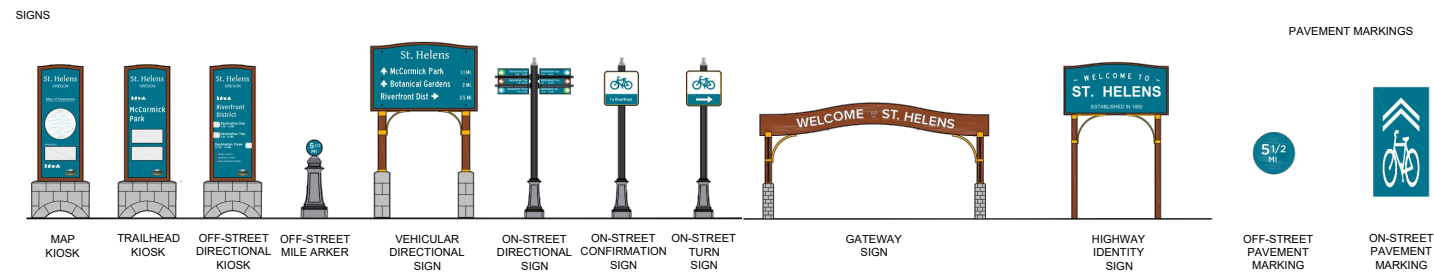

Sign Type	Design Intent Detail (Sheet #)
Map Kiosk	Sheet 4-7
Trailhead Kiosk	Sheet 4-7
Off-Street Directional Kiosk	Sheet 4-7
Off-Street Mile Marker	Sheet 8
Vehicular Directional Sign	Sheet 10-11
On-Street Directional Sign	Sheet 12
On-Street Confirmation Sign	Sheet 13-14
On-Street Turn Sign	Sheet 13-14
Gateway Sign	Sheet 16-17
Highway Identity Sign	Sheet 18-19
Off-Street Pavement Marking	Sheet 9
On-Street Pavement Marking	Sheet 15



### GENERAL NOTES

- These drawings are intended to illustrate sign placement only and are not for construction. All final engineering and conditions of the project are the responsibility of the fabricator. Shop drawings by the fabricator must be submitted for approval, prior to proceeding with fabrication.
- Sign placement drawings note approximate sign location. Locations to be verified and additional plans may be required prior to installation.
- Scaled examples shown are for reference only, and intended to illustrate the sign type only. The number and orientation of sign blades will differ for each sign. Examples do not necessarily reflect actual site conditions. Detailed site surveys are required prior to fabrication and installation.

City of St. Helens

CLIENT

St. Helens Wayfinding

PROJECT

October 2017

DOCUMENT ISSUE

Sign Schedule

SHEET TITLE

SP 1

SHEET NUMBER

GENERAL NOTES

- These drawings are intended to illustrate sign placement only and are not for construction. All final engineering and conditions of the project are the responsibility of the fabricator. Shop drawings by the fabricator must be submitted for approval, prior to proceeding with fabrication.
- Sign placement drawings note approximate sign location. Locations to be verified and additional plans may be required prior to installation.
- Scaled examples shown are for reference only, and intended to illustrate the sign type only. The number and orientation of sign blades will differ for each sign. Examples do not necessarily reflect actual site conditions. Detailed site surveys are required prior to fabrication and installation.

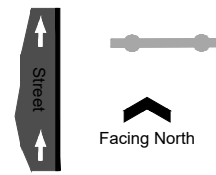
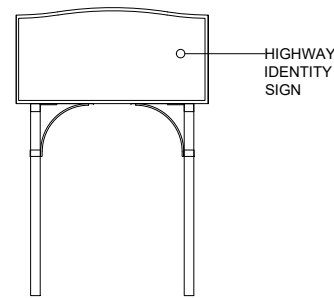

Schematic - Above View

1 HWY 30 SOUTH OF FIRLOCK BLVD  
NTS

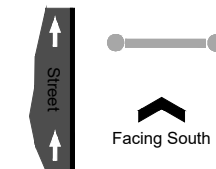
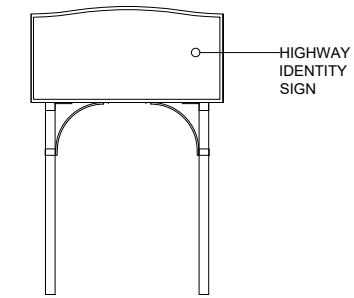

Schematic - Above View

2 HWY 30 SOUTH OF LIBERTY HILL RD  
NTS

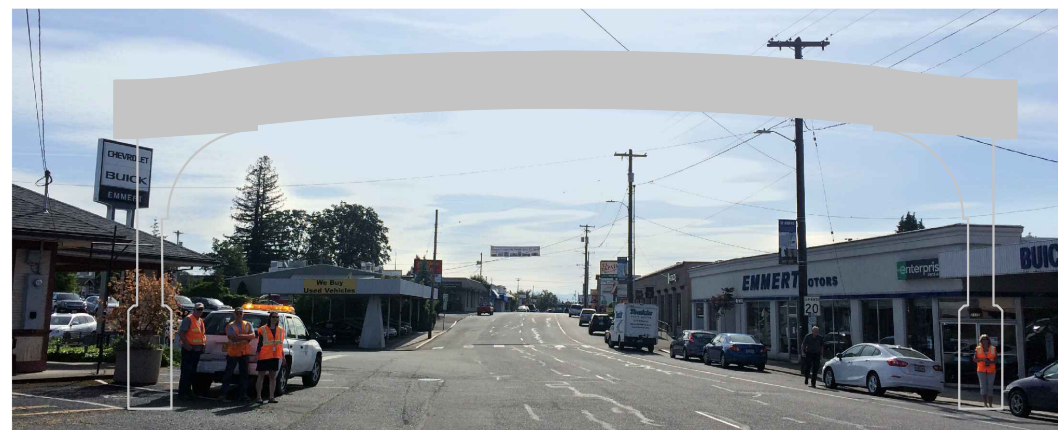

NOTE: POTENTIAL LOCATION. FINAL LOCATION TO BE DETERMINED AFTER FURTHER STUDY.

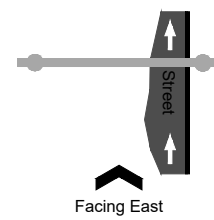
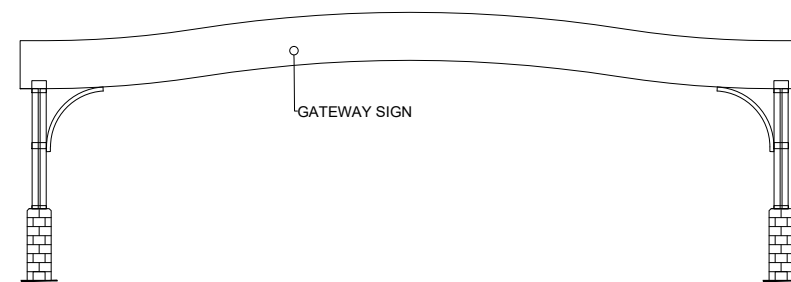

Schematic - Above View

3 COLUMBIA BLVD AT MILTON WAY  
NTS

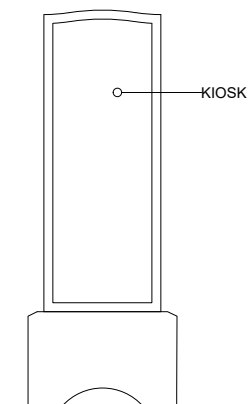
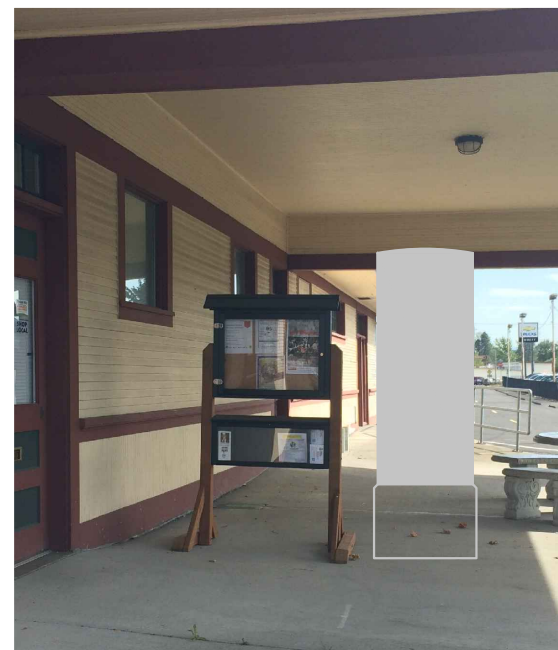

4 COLUMBIA BLVD AT MILTON WAY  
NTS

City of St. Helens

CLIENT

St. Helens Wayfinding

PROJECT

October 2017

DOCUMENT ISSUE

Sign Placement

SHEET TITLE

SP 2

SHEET NUMBER

GENERAL NOTES

- These drawings are intended to illustrate sign placement only and are not for construction. All final engineering and conditions of the project are the responsibility of the fabricator. Shop drawings by the fabricator must be submitted for approval, prior to proceeding with fabrication.
- Sign placement drawings note approximate sign location. Locations to be verified and additional plans may be required prior to installation.
- Scaled examples shown are for reference only, and intended to illustrate the sign type only. The number and orientation of sign blades will differ for each sign. Examples do not necessarily reflect actual site conditions. Detailed site surveys are required prior to fabrication and installation.

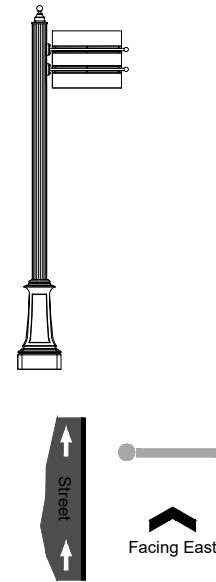
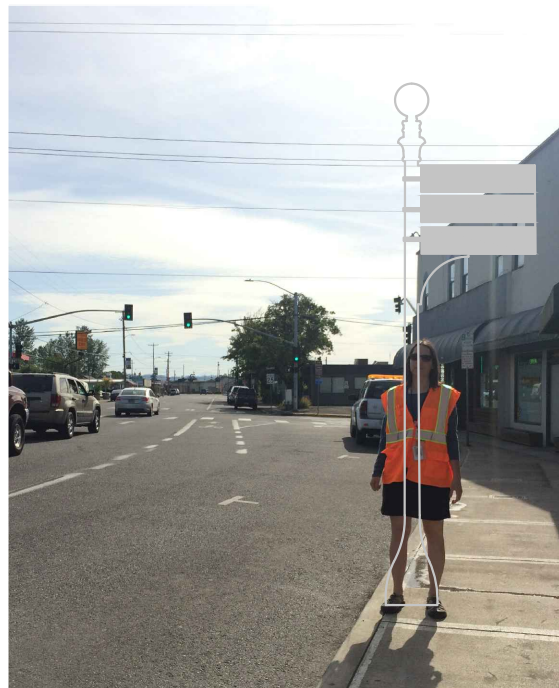

Schematic - Above View

5 COLUMBIA BLVD WEST OF S 18TH STREET  
 NTS

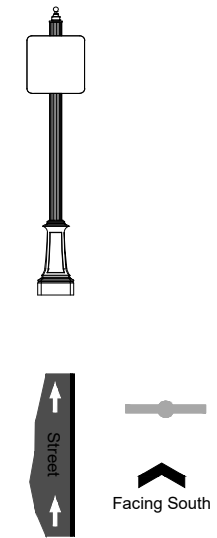

Schematic - Above View

6 S 18TH STREET SOUTH OF COLUMBIA BLVD  
 NTS

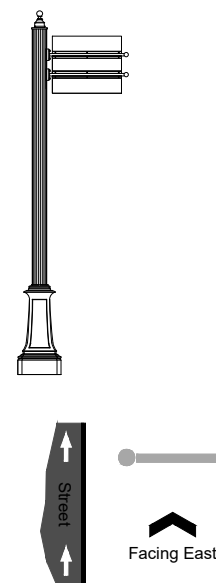

Schematic - Above View

7 COLUMBIA BLVD WEST OF S 15TH STREET  
 NTS

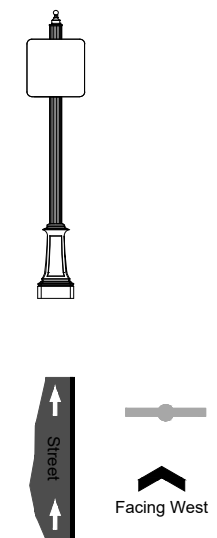

Schematic - Above View

8 ST HELENS STREET WEST OF N 13TH STREET  
 NTS

City of St. Helens

CLIENT

St. Helens Wayfinding

PROJECT

October 2017

DOCUMENT ISSUE

Sign Placement

SHEET TITLE

SP 3

SHEET NUMBER

GENERAL NOTES

- These drawings are intended to illustrate sign placement only and are not for construction. All final engineering and conditions of the project are the responsibility of the fabricator. Shop drawings by the fabricator must be submitted for approval, prior to proceeding with fabrication.
- Sign placement drawings note approximate sign location. Locations to be verified and additional plans may be required prior to installation.
- Scaled examples shown are for reference only, and intended to illustrate the sign type only. The number and orientation of sign blades will differ for each sign. Examples do not necessarily reflect actual site conditions. Detailed site surveys are required prior to fabrication and installation.

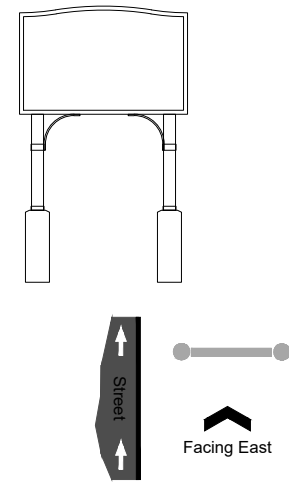
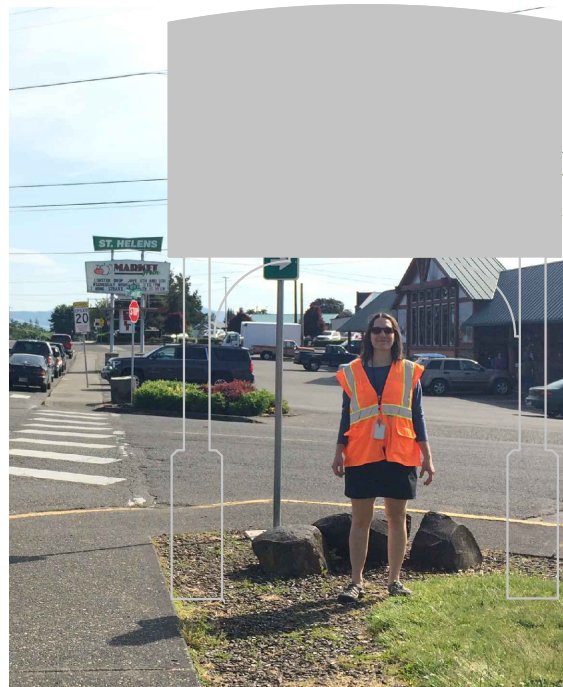

Schematic - Above View

9 COLUMBIA BLVD WEST OF S 12TH STREET  
 NTS

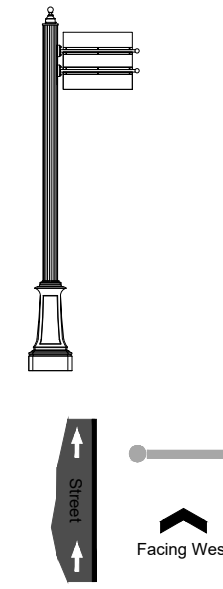
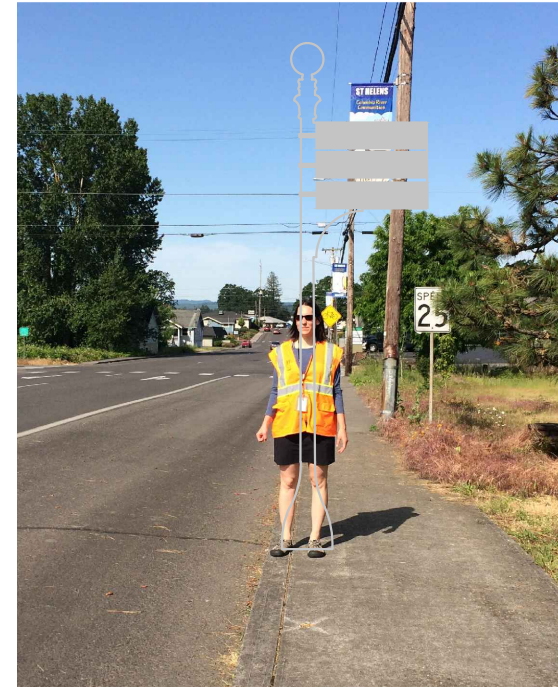

Schematic - Above View

10 ST HELENS STREET WEST OF N 14TH STREET  
 NTS

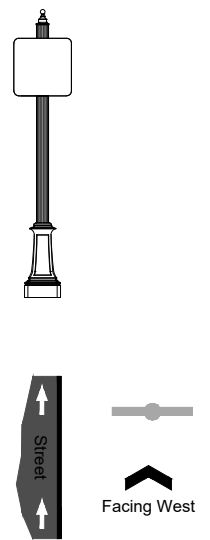
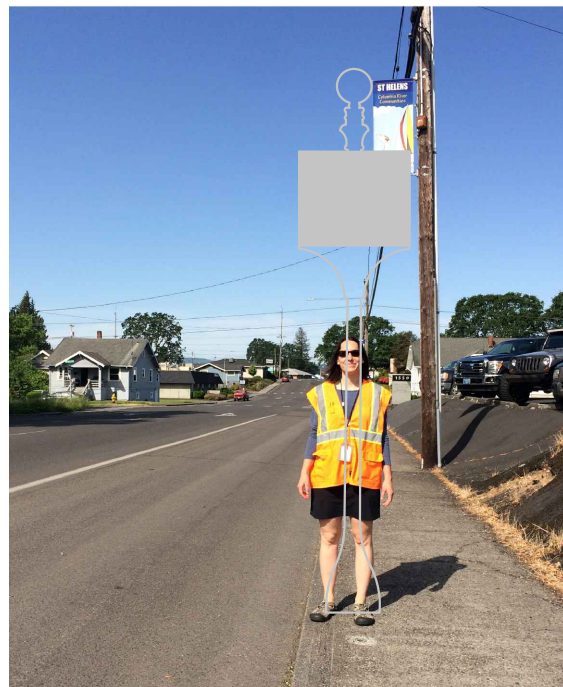

Schematic - Above View

11 ST HELENS STREET WEST OF N 15TH STREET  
 NTS

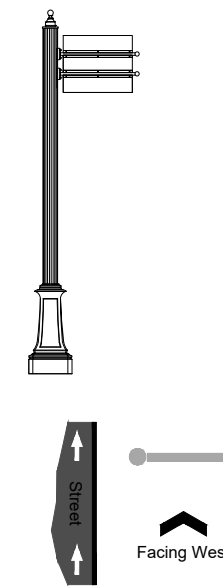

Schematic - Above View

12 ST HELENS ST WEST OF N 17TH STREET  
 NTS

City of St. Helens

CLIENT

St. Helens Wayfinding

PROJECT

October 2017

DOCUMENT ISSUE

Sign Placement

SHEET TITLE

SP 4

SHEET NUMBER



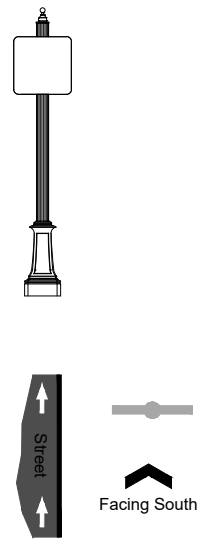

Schematic - Above View

13 N 18TH STREET SOUTH OF ST HELENS STREET  
NTS

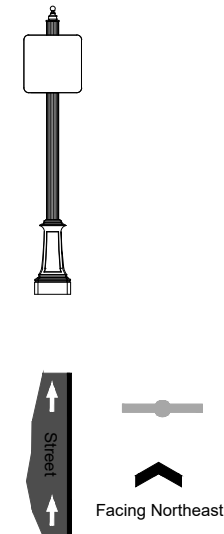

Schematic - Above View

14 COLUMBIA BLVD AT S 9TH STREET  
NTS

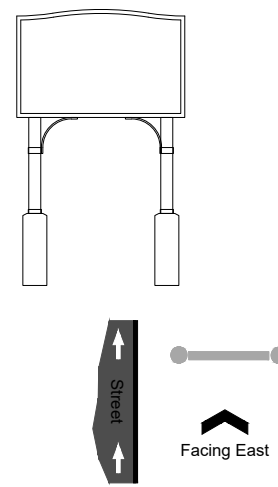

Schematic - Above View

15 COLUMBIA BLVD WEST OF S 8TH STREET  
NTS

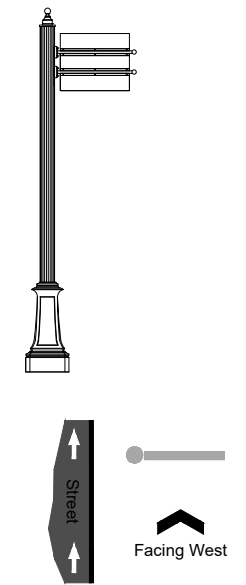

Schematic - Above View

16 COLUMBIA BLVD WEST OF N 5TH STREET  
NTS

GENERAL NOTES

- These drawings are intended to illustrate sign placement only and are not for construction. All final engineering and conditions of the project are the responsibility of the fabricator. Shop drawings by the fabricator must be submitted for approval, prior to proceeding with fabrication.
- Sign placement drawings note approximate sign location. Locations to be verified and additional plans may be required prior to installation.
- Scaled examples shown are for reference only, and intended to illustrate the sign type only. The number and orientation of sign blades will differ for each sign. Examples do not necessarily reflect actual site conditions. Detailed site surveys are required prior to fabrication and installation.

City of St. Helens

CLIENT

St. Helens Wayfinding

PROJECT

October 2017

DOCUMENT ISSUE

Sign Placement

SHEET TITLE

SP 5

SHEET NUMBER

GENERAL NOTES

- These drawings are intended to illustrate sign placement only and are not for construction. All final engineering and conditions of the project are the responsibility of the fabricator. Shop drawings by the fabricator must be submitted for approval, prior to proceeding with fabrication.
- Sign placement drawings note approximate sign location. Locations to be verified and additional plans may be required prior to installation.
- Scaled examples shown are for reference only, and intended to illustrate the sign type only. The number and orientation of sign blades will differ for each sign. Examples do not necessarily reflect actual site conditions. Detailed site surveys are required prior to fabrication and installation.

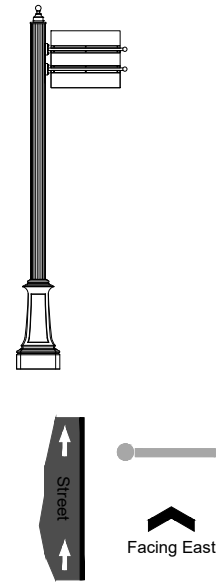
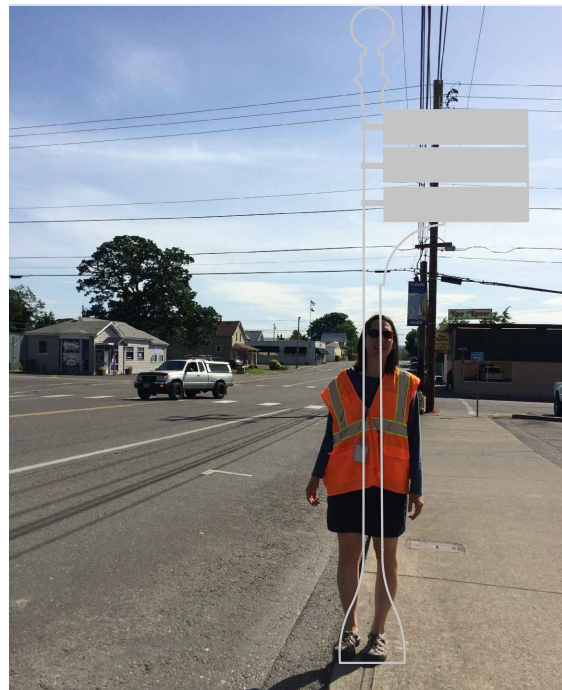

Schematic - Above View

17 COLUMBIA BLVD WEST OF N 4TH ST  
 NTS

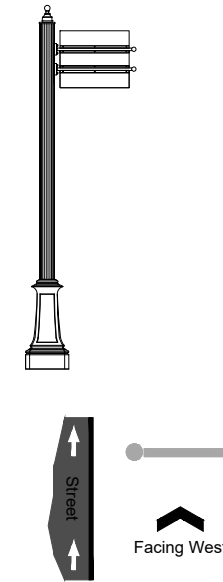

Schematic - Above View

18 COLUMBIA BLVD WEST OF N 3RD STREET  
 NTS

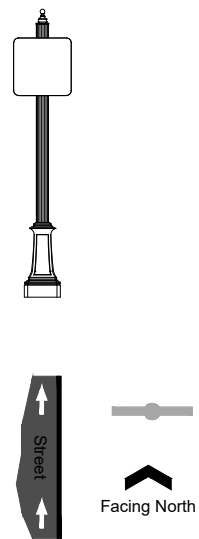

Schematic - Above View

19 S 3RD STREET SOUTH OF COLUMBIA BLVD  
 NTS

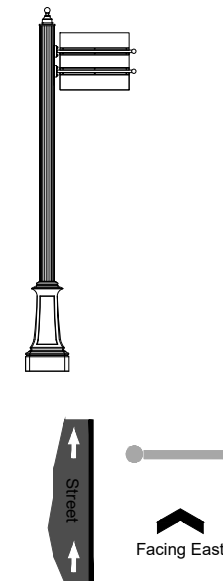
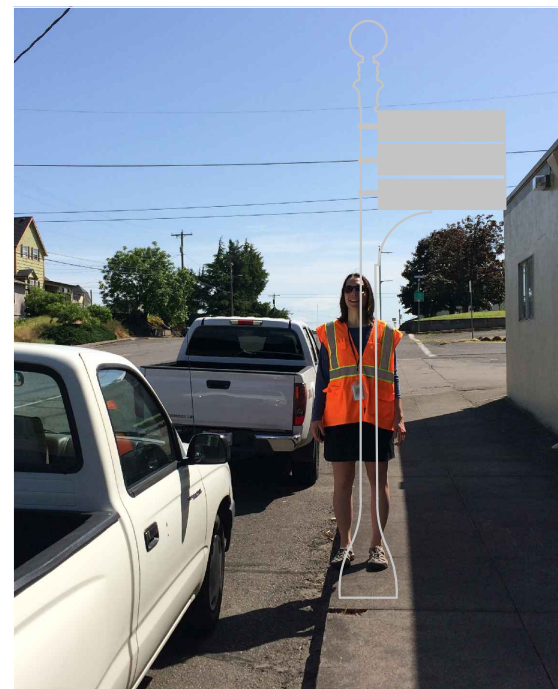

Schematic - Above View

20 ST HELENS STREET WEST OF S 3RD STREET  
 NTS

City of St. Helens

CLIENT

St. Helens Wayfinding

PROJECT

October 2017

DOCUMENT ISSUE

Sign Placement

SHEET TITLE

SP 6

SHEET NUMBER

GENERAL NOTES

- These drawings are intended to illustrate sign placement only and are not for construction. All final engineering and conditions of the project are the responsibility of the fabricator. Shop drawings by the fabricator must be submitted for approval, prior to proceeding with fabrication.
- Sign placement drawings note approximate sign location. Locations to be verified and additional plans may be required prior to installation.
- Scaled examples shown are for reference only, and intended to illustrate the sign type only. The number and orientation of sign blades will differ for each sign. Examples do not necessarily reflect actual site conditions. Detailed site surveys are required prior to fabrication and installation.

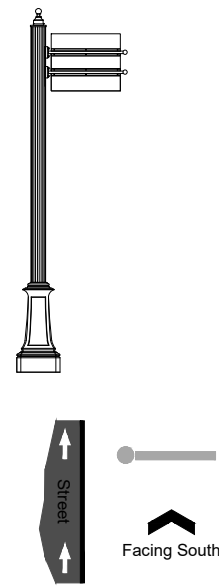

Schematic - Above View

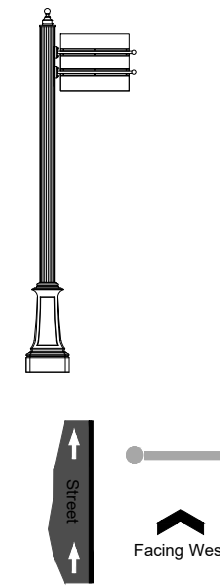

Schematic - Above View

21 S 3RD STREET NORTH OF ST HELENS STREET  
NTS

22 ST HELENS STREET WEST OF S 3RD STREET  
NTS

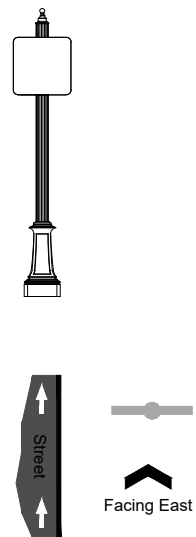
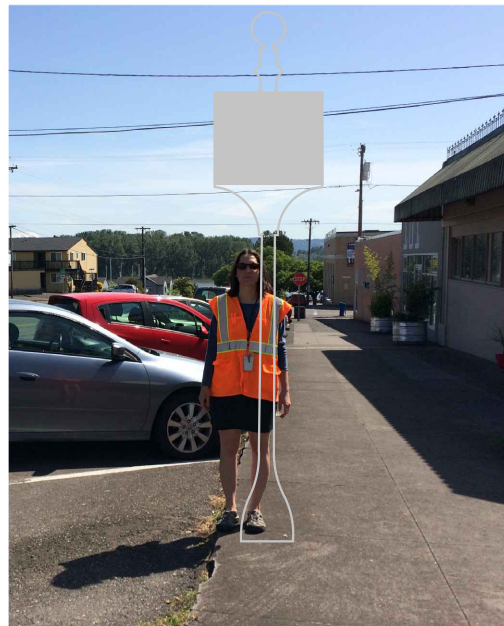

Schematic - Above View

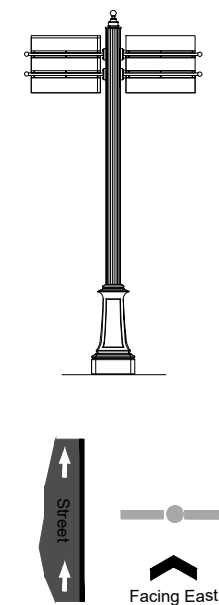

Schematic - Above View

23 ST HELENS STREET WEST OF S 1ST STREET  
NTS

24 S 1ST STREET SOUTH OF ST HELENS STREET  
NTS

City of St. Helens

CLIENT

St. Helens Wayfinding

PROJECT

October 2017

DOCUMENT ISSUE

Sign Placement

SHEET TITLE

SP 7

SHEET NUMBER



25 S 1ST STREET AT PLAZA SQUARE  
NTS

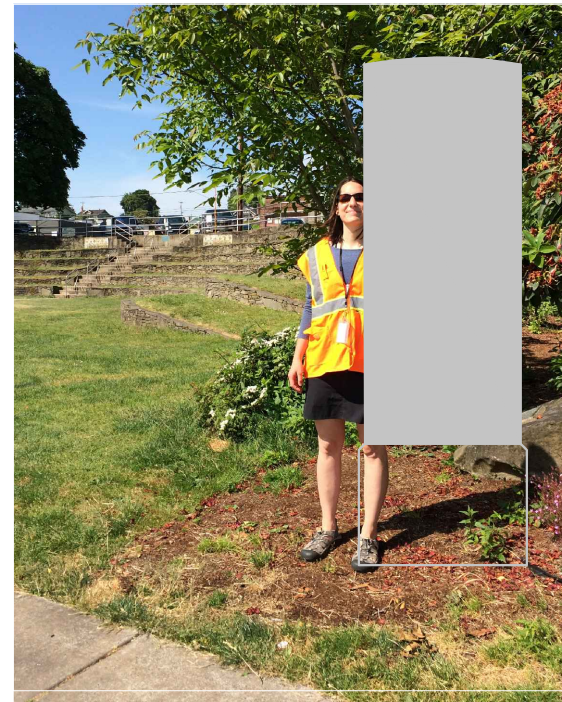
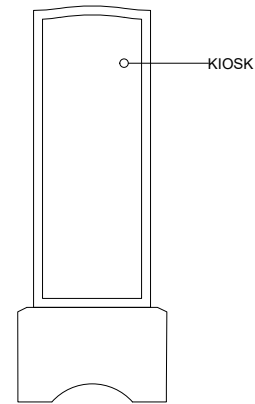

26 COLUMBIA VIEW PARK  
NTS

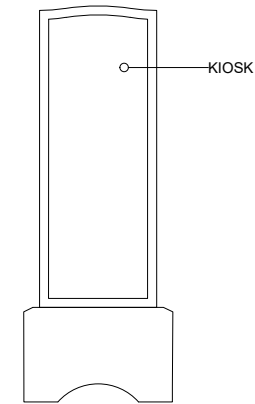

27 COLUMBIA BLVD EAST OF S 1ST STREET  
NTS

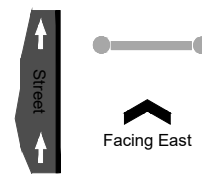
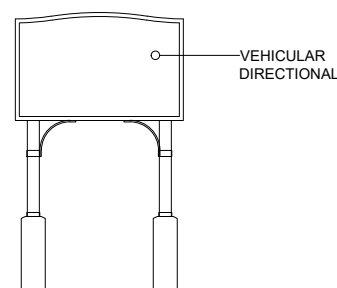

Schematic - Above View



28 RIVER STREET SOUTH OF BOAT LAUNCH  
NTS

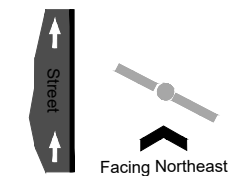
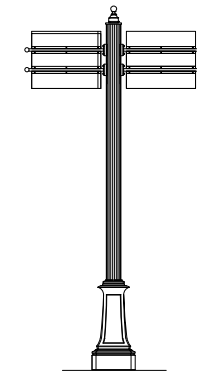

Schematic - Above View

GENERAL NOTES

- These drawings are intended to illustrate sign placement only and are not for construction. All final engineering and conditions of the project are the responsibility of the fabricator. Shop drawings by the fabricator must be submitted for approval, prior to proceeding with fabrication.
- Sign placement drawings note approximate sign location. Locations to be verified and additional plans may be required prior to installation.
- Scaled examples shown are for reference only, and intended to illustrate the sign type only. The number and orientation of sign blades will differ for each sign. Examples do not necessarily reflect actual site conditions. Detailed site surveys are required prior to fabrication and installation.

City of St. Helens

CLIENT

St. Helens Wayfinding

PROJECT

October 2017

DOCUMENT ISSUE

Sign Placement

SHEET TITLE

SP 8

SHEET NUMBER

# HIGHWAY 30 SIGN INVENTORY



## GENERAL NOTES

- These drawings are intended to illustrate sign placement only and are not for construction. All final engineering and conditions of the project are the responsibility of the fabricator. Shop drawings by the fabricator must be submitted for approval, prior to proceeding with fabrication.
- Sign placement drawings note approximate sign location. Locations to be verified and additional plans may be required prior to installation.
- Scaled examples shown are for reference only, and intended to illustrate the sign type only. The number and orientation of sign blades will differ for each sign. Examples do not necessarily reflect actual site conditions. Detailed site surveys are required prior to fabrication and installation.



See Below



See Above

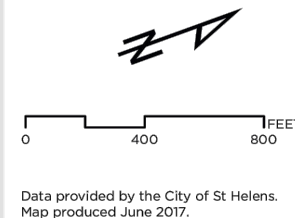

NOTE:  
ALL NEW SIGNS SHALL HAVE TEXT HEIGHT AT A SCALE VISIBLE  
AT 50 MPH OR THE 85TH PERCENTILE OF AVERAGE TRAFFIC  
SPEED, WHICH EVER IS GREATER.

City of St. Helens

CLIENT

St. Helens Wayfinding

PROJECT

October 2017

DOCUMENT ISSUE

HWY 30 Sign Inventory

SHEET TITLE

SP 9

SHEET NUMBER

# HWY 30 DEMO & RELOCATION SCHEDULE (1 of 2)

Number	Description	Direction	Type	Disposition	Responsible ODOT department	Details	Location of New Consolidated Sign	Link to Existing Condition Photo of Sign	Other
1	Railroad Intersection Ahead	Southbound	Regulatory	To remain					outside city limits
2	Stoplight Ahead	Southbound	Regulatory	To remain					outside city limits
3	Begin Right Turn Lane - Yield to Bikes	Southbound	Regulatory	To remain					outside city limits
4	Right Lane Must Turn Right	Southbound	Regulatory	To remain					outside city limits
5	US 30 Astoria/Portland Directional	Intersection - Parallel to Hwy		To remain					outside city limits
6	Speed 45	Southbound	Regulatory	To remain		needs cleaning			outside city limits
7	St. Helens Church of Christ	Southbound		To be removed		ODOT check with District to see if still active or provide contact info for City follow up		<a href="https://apd.app.box.com/file/179772052530">https://apd.app.box.com/file/179772052530</a>	outside city limits
8	Speed 40	Southbound	Regulatory	To remain					outside city limits
9	State Offices DMV Right Lane	Southbound		To be replaced		Replace with directional sign include "DMV" only	same location	<a href="https://apd.app.box.com/file/179772137248">https://apd.app.box.com/file/179772137248</a>	outside city limits
10	Rainier/Scappoose Mileage Sign (Pittsburg Rd.)	Intersection - Parallel to Hwy		To remain					outside city limits
11	Entering St. Helens	Southbound		To be replaced		Replace with new Highway Identity sign	same location	<a href="https://apd.app.box.com/file/179769125922">https://apd.app.box.com/file/179769125922</a>	
12	Railroad Intersection Ahead	Southbound	Regulatory	To remain					
13	State Offices DMV Directional	Southbound		To remain					outside city limits
14	Speed 35	Southbound	Regulatory	To remain		Suggest adding speed feedback sign			
15	Stoplight Ahead	Southbound	Regulatory	To remain					
16	Lefthand Turn Prohibited	Southbound	Regulatory	To remain					
17	Oregon Visitors Information - Chamber of Commerce Next Left	Southbound		To be removed		Replaced by directional sign 19		<a href="https://apd.app.box.com/file/179769682391">https://apd.app.box.com/file/179769682391</a>	<a href="https://apd.app.box.com/file/179769546743">https://apd.app.box.com/file/179769546743</a>
18	Scappoose/Portland Mileage & Rainier/Astoria Mileage	Intersection - Parallel to Hwy		To remain					
19	Courthouse City Park Next Left / Anchor Symbol	Southbound		To be replaced		Consolidate signs 17, 19, 22, 23. Selected destinations (Houlton Bus Dist, left, Chamber of Commerce, left, Riverfront Dist, left) are for Columbia Blvd at location 19 and remove all others	same location	<a href="https://apd.app.box.com/file/179769682391">https://apd.app.box.com/file/179769682391</a>	
20	CC Rider	Southbound		To remain					
21	Right Lane Must Turn Right	Southbound	Regulatory	To remain					
22	Ind. Area / City Center / Co. City Bldgs. & Post Office & Library/Columbia Center	Southbound		To be removed		Replaced by directional sign 19		<a href="https://apd.app.box.com/file/179769682391">https://apd.app.box.com/file/179769682391</a>	<a href="https://apd.app.box.com/file/179770049499">https://apd.app.box.com/file/179770049499</a>
23	Columbia Center Arrow & Columbia County Fairgrounds / Vernonia / Mist Mileage	Southbound		To be removed		Replaced by directional sign 19		<a href="https://apd.app.box.com/file/179769682391">https://apd.app.box.com/file/179769682391</a>	<a href="https://apd.app.box.com/file/179770370240">https://apd.app.box.com/file/179770370240</a>
24	City Center / Portland/Scappoose/Rainier/Astoria Mileage	Intersection - Parallel to Hwy		To be replaced		Replace with directional sign "Riverfront Dist", straight, and leave the same mileage info for Rainier/Scappoose/Astoria.	same location	<a href="https://apd.app.box.com/file/179770475184">https://apd.app.box.com/file/179770475184</a>	
25	Columbia Center & City Center/Co. City Bldgs.	Intersection - Northbound		To be removed		Destinations are library, right, courthouse plaza, right, city hall, right	before turn lane, near sign 88 <a href="https://apd.app.box.com/file/179768248744">https://apd.app.box.com/file/179768248744</a>	<a href="https://apd.app.box.com/file/179770460390">https://apd.app.box.com/file/179770460390</a>	
26	No Parking	Southbound	Regulatory	To remain					
27	No Parking	Southbound	Regulatory	To remain					
28	Milton Creek/Scappoose Bay Watershed	Southbound		To remain					
29	No Parking	Southbound	Regulatory	To remain					
30	No Parking	Southbound	Regulatory	To remain					
31	Speed 35	Southbound	Regulatory	To remain					
32	No Parking	Southbound	Regulatory	To remain					
33	Lodging Right 1/4 Mile (Best Western)	Southbound		To be removed		ODOT to check with OTE to see if it can be removed (not likely) or provide contact info for City follow up		<a href="https://apd.app.box.com/file/179771104275">https://apd.app.box.com/file/179771104275</a>	
34	No Parking & Speed 35	Southbound	Regulatory	To remain					
35	No Parking	Southbound	Regulatory	To remain					
36	Begin Right Turn Lane - Yield to Bikes	Southbound	Regulatory	To remain					
37	Right Lane Must Turn Right	Southbound	Regulatory	To remain					
38	No Parking	Southbound	Regulatory	To remain					
39	Sheriff / Jail / State Police Next Left	Southbound		To be replaced		Replace with directional sign "Sherriff's Office" left, "State Police" left	same location	<a href="https://apd.app.box.com/file/179771474510">https://apd.app.box.com/file/179771474510</a>	
41	US 30	Southbound		To remain					
40	Rainier/Scappoose Mileage / US 30	Intersection - Parallel to Hwy		To remain					
42	CC Rider	Southbound		To remain					
43	Begin Right Turn Lane - Yield to Bikes	Southbound	Regulatory	To remain					
44	Right Lane Must Turn Right	Southbound	Regulatory	To remain					
45	Gable Road / Industrial Area / N.G. Armory / SR. High School / Co. Fairgrounds Mileage	Intersection - Southbound		To be removed		Replace with new sign, destinations to include "McCormick Park" left, "Armory" left, "High School" right,	near sign 42 <a href="https://apd.app.box.com/file/179771618448">https://apd.app.box.com/file/179771618448</a>	<a href="https://apd.app.box.com/file/179771645715">https://apd.app.box.com/file/179771645715</a>	
46	Gable Road/ SR. High School / Co Fairgrounds / Ind. Area / NG Armory / Co - City Bldgs Mileage	Intersection - Northbound		To be removed		Replace with new directional sign located south of beginning of right turn lane. Destinations: "Fairgrounds" left, "High School" left, "Armory" right, "McCormick Park" right	near sign 75 <a href="https://apd.app.box.com/file/179767527372">https://apd.app.box.com/file/179767527372</a>	<a href="https://apd.app.box.com/file/179771645715">https://apd.app.box.com/file/179771645715</a>	
47	US 30 & Astoria/Portland Arrow	Intersection - Parallel to Hwy		To remain					
48	No Parking	Southbound	Regulatory	To remain					
49	No Parking	Southbound	Regulatory	To remain					
50	High School Athletic Field	Southbound		To remain					
51	Speed 45	Southbound	Regulatory	To remain					outside city limits
52	Center Lane Turn Only	Southbound	Regulatory	To be replaced		or cleaned	same location	<a href="https://apd.app.box.com/file/179771775057">https://apd.app.box.com/file/179771775057</a>	
53	Railroad Intersection Millard Rd.	Southbound	Regulatory	To remain		needs cleaning		<a href="https://apd.app.box.com/file/179771811950">https://apd.app.box.com/file/179771811950</a>	outside city limits
55	Begin Right Turn Lane - Yield to Bikes	Southbound	Regulatory	To remain					outside city limits
54	State Police Arrow	Southbound		To remain					outside city limits
56	Right Lane Must Turn Right	Southbound	Regulatory	To remain					outside city limits



## GENERAL NOTES

- These drawings are intended to illustrate sign placement only and are not for construction. All final engineering and conditions of the project are the responsibility of the fabricator. Shop drawings by the fabricator must be submitted for approval, prior to proceeding with fabrication.
- Sign placement drawings note approximate sign location. Locations to be verified and additional plans may be required prior to installation.
- Scaled examples shown are for reference only, and intended to illustrate the sign type only. The number and orientation of sign blades will differ for each sign. Examples do not necessarily reflect actual site conditions. Detailed site surveys are required prior to fabrication and installation.

City of St. Helens

CLIENT

St. Helens Wayfinding

PROJECT

October 2017

DOCUMENT ISSUE

HWY 30 Sign Relocation Part 1

SHEET TITLE

SP 10

SHEET NUMBER

# HWY 30 DEMO & RELOCATION SCHEDULE (2 of 2)

Number	Description	Direction	Type	Disposition	Responsible ODOT department	Details	Location of New Consolidated Sign	Link to Existing Condition Photo of Sign	Other
57	Scappoose & St. Helens Arrows / US 30	Intersection - Parallel to Hwy		To remain					outside city limits
58	Millard Road / Grange Hall Arrow	Southbound		To remain					outside city limits
59	Speed 45	Southbound	Regulatory	To remain					outside city limits
60	St. Helens/Scappoose Arrow & US 30	Intersection - Parallel to Hwy		To remain					outside city limits
61	Center Lane Turn Only	Southbound	Regulatory	To remain					outside city limits
62	Begin Right Turn Lane - Yield to Bikes	Northbound	Regulatory	To remain					outside city limits
63	State Police Arrow	Northbound		To remain					outside city limits
64	Millard Rd. & Grange Hall Arrow	Northbound		To remain					outside city limits
65	Speed 45	Northbound	Regulatory	To remain		needs cleaning		<a href="https://apd.app.box.com/file/179766412505">https://apd.app.box.com/file/179766412505</a>	outside city limits
66	Center Lane Turn Only	Northbound	Regulatory	To remain					outside city limits
67	Adopt a Landscape Program: The Saint Helens Church of Christ	Northbound		To remain		Is this still active/can it be removed?			outside city limits
68	Next Right: Camping/Food	Northbound		To be removed	ODOT to check with OTE to see if it can be removed (not likely) or provide contact info for City follow up			<a href="https://apd.app.box.com/file/17976662944">https://apd.app.box.com/file/17976662944</a>	outside city limits
69	Speed 35	Northbound	Regulatory	To remain		Suggest adding speed feedback sign			outside city limits
70	Welcome St. Helens	Northbound		To be relocated		Replace with new Highway Identity sign	Location TBD	<a href="https://apd.app.box.com/file/179767124756">https://apd.app.box.com/file/179767124756</a>	outside city limits
71	McNulty Creek Scappoose Bay Watershed	Northbound		To remain					
72	CC Rider Arrow	Northbound		To remain					
73	Sherriff/Jail/State Police Next Right	Northbound		To be replaced		Replace with directional sign "Transit Center" forward, "Sheriff's Office" right, "State Police" right	same location	<a href="https://apd.app.box.com/file/179767455443">https://apd.app.box.com/file/179767455443</a>	
74	Entering St. Helens/Lewis & Clark Trail	Northbound		To remain					
75	Gable Road Signal Ahead	Northbound	Regulatory	To remain					
76	Begin Right Turn - Yield to Bikes	Northbound	Regulatory	To remain					
77	Right Lane Must Turn Right	Northbound	Regulatory	To remain					
78	Lodging Left 1/4 Mile	Northbound		To be removed	ODOT to check with OTE to see if it can be removed (not likely) or provide contact info for City follow up			<a href="https://apd.app.box.com/file/179767826537">https://apd.app.box.com/file/179767826537</a>	
79	Speed 35 No Parking	Northbound	Regulatory	To remain					
80	Welcome to St. Helens/National Community Achievement Winner 1958	Northbound		To be relocated			Location TBD	<a href="https://apd.app.box.com/file/179767729911">https://apd.app.box.com/file/179767729911</a>	
81	Vernonia/Mist Mileage Arrow	Northbound		To remain		240 south			
82	Lodging Arrow	Northbound		To be removed	ODOT to check with OTE to see if it can be removed (not likely) or provide contact info for City follow up			<a href="https://apd.app.box.com/file/179768011655">https://apd.app.box.com/file/179768011655</a>	
83	Center Lane Turn Only	Northbound	Regulatory	To remain					
84	Right 1/4 Mile Natl. Downtown Historic District/Riverfront District/Columbia View Amphitheater	Northbound		To be removed	ODOT to check with OTE to see if it can be removed (not likely) or provide contact info for City follow up	Replaced by directional sign 86		<a href="https://apd.app.box.com/file/179768046601">https://apd.app.box.com/file/179768046601</a>	
85	Speed 35	Northbound	Regulatory	To remain					
86	Oregon Visitors Information: Chamber of Commerce Rt. at Signal	Northbound		To be removed				<a href="https://apd.app.box.com/file/179768138188">https://apd.app.box.com/file/179768138188</a>	
87	Milton Creek Scappoose Bay Watershed	Northbound		To remain					
88	Signal Ahead	Northbound	Regulatory	To remain					
89	Right Turn Begins - Yield to Bikes	Northbound	Regulatory	To remain					
90	Courthouse City Park / Marina Anchor Next Right	Northbound		To be replaced		Replace with directional sign "Riverfront Dist" right, "Courthouse Plaza" right, "Library" right, and "Post Office" right	same location	<a href="https://apd.app.box.com/file/179768376664">https://apd.app.box.com/file/179768376664</a>	
91	CC Rider Arrow	Northbound		To remain					
92	No Parking	Northbound	Regulatory	To remain					
93	Right Natl. Downtown Historic District/Riverfront District/Columbia View Amphitheater Mileage	Northbound		To be removed	ODOT to check with OTE to see if it can be removed (not likely) or provide contact info for City follow up	Replaced by directional sign 90	<a href="https://apd.app.box.com/file/179768376664">https://apd.app.box.com/file/179768376664</a>	<a href="https://apd.app.box.com/file/179768780591">https://apd.app.box.com/file/179768780591</a>	
94	Right Lane Must Turn Right	Northbound	Regulatory	To remain					
95	Columbia Blvd. / Post Office Arrow / Library Columbia Learning Center Arrow	Northbound		To be removed		Replaced by directional sign 90	<a href="https://apd.app.box.com/file/179768376664">https://apd.app.box.com/file/179768376664</a>	<a href="https://apd.app.box.com/file/179769051426">https://apd.app.box.com/file/179769051426</a>	
96	No Right Hand Turn / No Parking	Northbound	Regulatory	To remain					
97	Center Lane Turn Only	Northbound	Regulatory	To remain					
98	State Offices / DMV Left Lane	Northbound		To be removed		Replaced by directional sign 102	<a href="https://apd.app.box.com/file/17976570971">https://apd.app.box.com/file/17976570971</a>	<a href="https://apd.app.box.com/file/179769159886">https://apd.app.box.com/file/179769159886</a>	
99	Railroad Intersection Ahead	Northbound	Regulatory	To remain		trim back landscape			
100	Speed 40	Northbound	Regulatory	To remain		trim back landscape			
101	Begin Right Turn - Yield to Bikes	Northbound	Regulatory	To remain					
102	CC Rider Arrow	Northbound		To remain		Add directional sign DMV "left", Middle School "right"		<a href="https://apd.app.box.com/file/17976570971">https://apd.app.box.com/file/17976570971</a>	
103	Middle School Arrow	Northbound		To be removed		Replaced by directional sign 102	<a href="https://apd.app.box.com/file/17976570971">https://apd.app.box.com/file/17976570971</a>	<a href="https://apd.app.box.com/file/179765900063">https://apd.app.box.com/file/179765900063</a>	
104	Right Lane Must Turn Right	Northbound	Regulatory	To remain					
105	State Offices DMV Arrow	Northbound		To be removed		Replaced by directional sign 102	<a href="https://apd.app.box.com/file/17976570971">https://apd.app.box.com/file/17976570971</a>	<a href="https://apd.app.box.com/file/179765788321">https://apd.app.box.com/file/179765788321</a>	
106	Pittsburg Rd / Yankton Arrow	Northbound		To remain		Add "Transit Center" right		<a href="https://apd.app.box.com/file/179765810214">https://apd.app.box.com/file/179765810214</a>	
107	Speed 45	Northbound	Regulatory	To remain					
108	Intersection Ahead	Northbound	Regulatory	To remain				<a href="https://apd.app.box.com/file/179766307045">https://apd.app.box.com/file/179766307045</a>	
109	Adopt-A-Highway Program - First Christian Church	Northbound		To be removed	ODOT check with District to see if still active or provide contact info for City follow up			<a href="https://apd.app.box.com/file/179766144866">https://apd.app.box.com/file/179766144866</a>	
110	Railroad Intersection Ahead	Northbound	Regulatory	To remain					
111	Right Lane Must Turn Right	Northbound	Regulatory	To remain					
112	Speed 50	Northbound	Regulatory	To be replaced		letters peeling off	same location	<a href="https://apd.app.box.com/file/179766421229">https://apd.app.box.com/file/179766421229</a>	
113	Police Chief Ralph Painter Memorial Highway	Northbound		To remain					



## GENERAL NOTES

- These drawings are intended to illustrate sign placement only and are not for construction. All final engineering and conditions of the project are the responsibility of the fabricator. Shop drawings by the fabricator must be submitted for approval, prior to proceeding with fabrication.
- Sign placement drawings note approximate sign location. Locations to be verified and additional plans may be required prior to installation.
- Scaled examples shown are for reference only, and intended to illustrate the sign type only. The number and orientation of sign blades will differ for each sign. Examples do not necessarily reflect actual site conditions. Detailed site surveys are required prior to fabrication and installation.

City of St. Helens

CLIENT

St. Helens Wayfinding

PROJECT

October 2017

DOCUMENT ISSUE

HWY 30 Sign Relocation Part 2

SHEET TITLE

SP 11

SHEET NUMBER